

# Chapter 3

## Steel Plant Refractories

D.H. Hubble, Chief Refractory Engineer, U.S. Steel Corp. (Retired)

### 3.1 Classification of Refractories

Refractories are the primary materials used by the steel industry in the internal linings of furnaces for making iron and steel, in vessels for holding and transporting metal and slag, in furnaces for heating steel before further processing, and in the flues or stacks through which hot gases are conducted. At the risk of oversimplification, they may, therefore, be said to be materials of construction that are able to withstand temperatures from 260–1850°C (500–3400°F).

As seen in Fig. 3.1, the melting point of refractory materials in the pure state varies from 1815–3315°C (3300°–6000°F). Refractories in service can tolerate only small amounts of melting

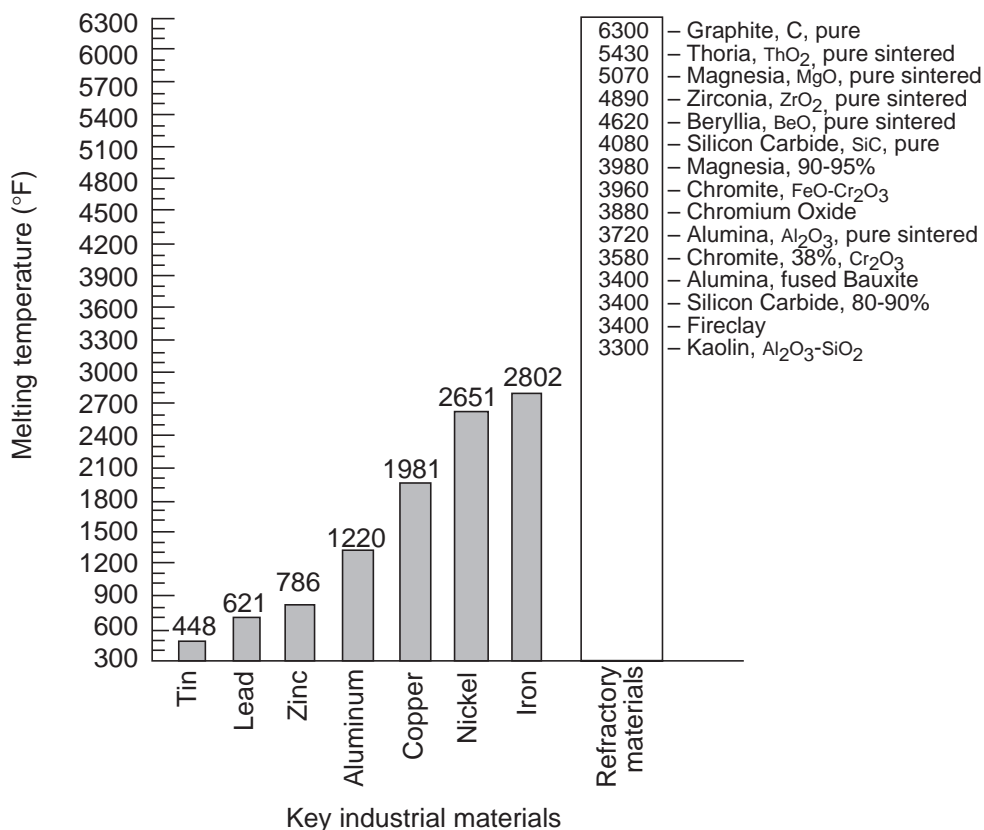


Fig. 3.1 Refractory and industrial materials melting point chart.

(1–5%) without loss of their important structural characteristics. Subsequent discussion will show, however, that the use of many such materials is limited by factors such as cost or instability in certain atmospheres. Also, fluxes present in the initial impure refractory and/or encountered in service can seriously reduce these melting points.

Refractories are expensive, and any failure in the refractories results in a great loss of production time, equipment, and sometimes the product itself. The type of refractories also will influence energy consumption and product quality. Therefore, the problem of obtaining refractories best suited to each application is of supreme importance. Economics greatly influence these problems, and the refractory best suited for an application is not necessarily the one that lasts the longest, but rather the one which provides the best balance between initial installed cost and service performance. This balance is never fixed, but is constantly shifting as a result of the introduction of new processes or new types of refractories. History reveals that refractory developments have occurred largely as the result of the pressure for improvement caused by the persistent search for superior metallurgical processes. The rapidity with which these ever recurring refractory problems have been solved has been a large factor in the rate of advancement of the iron and steel industry. To discuss the many factors involved in these problems and to provide information helpful to their solution are the objectives of this chapter.

Refractories are also vital in the safe operation of the processes and must not expose personnel to hazardous conditions during their manufacture, installation, use or during disposal following their use.

Refractories may be classified in a number of ways. From the chemical standpoint, refractory substances, in common with matter in general, are of three classes; namely, acid, basic, and neutral. Theoretically, acid refractories should not be used in contact with basic slags, gases or fumes whereas basic refractories can be best used in contact with a basic chemical environment. Actually, for various reasons, these rules are often violated. Hence, the time honored chemical classification is largely academic, and of little value as a guide to actual application. Also, the existence of a truly neutral refractory may be doubted. Classifications by use, such as blast furnace refractories or refractories for oxygen steelmaking, are generally too broad and are constantly subject to revision.

For our purposes, refractories will be classified with reference to the raw materials used in their preparation and to the minerals predominating after processing for use. This classification is believed to offer the best possibility for a clear understanding of the origin and nature of steel plant refractories.

### **3.1.1 Magnesia or Magnesia–Lime Group**

This group includes all refractories made from synthetic magnesites and dolomite. These constitute the most important group of refractories for the basic steelmaking processes. All these materials are used primarily as a source of magnesia (MgO).

#### **3.1.1.1 Magnesia**

Modern high-purity magnesias are produced in well controlled processes. The principal sources of magnesias are brines (often deep well type) and seawater. Magnesium hydroxide,  $\text{Mg}(\text{OH})_2$ , is precipitated from these sources by reaction with calcined dolomite or limestone; one source uses a novel reactor process. The resultant magnesium hydroxide slurry is filtered to increase its solids content. The filter cake can then be fed directly to a rotary kiln to produce refractory grade magnesia, but more commonly now the filter cake is calcined at about 900–1000°C (1650–1830°F), usually in multiple-hearth furnaces, to convert the magnesium hydroxide to active magnesia. This calcined magnesia is then briquetted or pelletized for firing into dense refractory-grade magnesia, usually in shaft kilns which reach temperatures around 2000°C (3630°F). The end product is sintered magnesia.

Fused magnesia is produced by melting a refractory grade magnesia or other magnesia precursor in an electric arc furnace. The molten mass is then removed from the furnace, cooled, and broken up to begin its path for use in refractories.

The impurities in magnesia are controlled by the composition of the original source of the magnesia (brine or seawater), the composition of the calcined dolomite or limestone, and the processing techniques. In particular the amounts and ratio of CaO and SiO<sub>2</sub> are rigorously controlled, and the B<sub>2</sub>O<sub>3</sub> is held to very low levels. The end results are high-grade refractory magnesias which are ready for processing into refractory products. Tables 3.1 through 3.4 show the compositions of different grades of magnesia.

**Table 3.1 Selected Sintered Magnesias Produced in North America (high CaO/SiO<sub>2</sub> ratio)**

Reference Code	SM-1	SM-2	SM-3
Chemical Analysis (wt%)			
CaO	2.2	2.2	0.8
SiO <sub>2</sub>	0.7	0.35	0.1
Al <sub>2</sub> O <sub>3</sub>	0.1	0.20	0.1
Fe <sub>2</sub> O <sub>3</sub>	0.2	0.20	0.1
B <sub>2</sub> O <sub>3</sub>	0.015	0.02	0.005
MgO	96.7	96.3	98.8
CaO/SiO <sub>2</sub> ratio	3.1	6.3	8.0
Bulk Density (kg/m <sup>3</sup> )	3400	3420	3400
Average Crystallite Size (μm)			
	~ 80	~ 90	~ 100

From Ref. 2.

**Table 3.2 Selected Sintered Magnesias Produced in Europe and the Middle East (high CaO/SiO<sub>2</sub> ratio)**

Reference Code	SM-4	SM-5	SM-6
Chemical Analysis (wt%)			
CaO	1.90	0.65	0.7
SiO <sub>2</sub>	0.20	0.15	0.03
Al <sub>2</sub> O <sub>3</sub>	0.05	0.06	0.03
Fe <sub>2</sub> O <sub>3</sub>	0.20	0.50	0.04
B <sub>2</sub> O <sub>3</sub>	0.015	0.008	0.005
MgO	97.5	98.5	99.2
CaO/SiO <sub>2</sub> ratio	9.5	4.3	23.3
Bulk Density (kg/m <sup>3</sup> )	3440	3450	3430– 3450
Average Crystallite Size (μm)			
	150–160	~ 100	70–90

From Ref. 2.

**Table 3.3 Selected Fused Magnesias Produced in North America**

Reference Code	FM-1	FM-2
Chemical Analysis (wt%)		
CaO	0.95	1.8
SiO <sub>2</sub>	0.30	0.5
Al <sub>2</sub> O <sub>3</sub>	0.11	0.2
Fe <sub>2</sub> O <sub>3</sub>	0.16	0.5
B <sub>2</sub> O <sub>3</sub>	0.0025	0.01
MgO	98.50	97.0
CaO/SiO <sub>2</sub> ratio	3.2	3.6
Bulk Density (kg/m <sup>3</sup> )	3530	3500
Average Crystallite Size (μm)	~ 780	~ 800

From Ref. 2.

**Table 3.4 Selected Sintered Magnesias Produced in North America (low CaO/SiO<sub>2</sub> ratio)**

Reference Code	SM-7	SM-8	SM-9
Chemical Analysis (wt%)			
CaO	0.7	0.80	0.9
SiO <sub>2</sub>	0.7	0.60	2.1
Al <sub>2</sub> O <sub>3</sub>	0.1	0.20	0.15
Fe <sub>2</sub> O <sub>3</sub>	0.2	0.20	0.35
B <sub>2</sub> O <sub>3</sub>	0.1	0.10	0.23
MgO	98.2	98.05	96.2
CaO/SiO <sub>2</sub> ratio	1.0	1.3	0.4
Bulk Density (kg/m <sup>3</sup> )	3330	3340	3260
Average Crystallite Size (μm)	50-60	~ 60	~ 40

From Ref. 2.

High purity is quite important because MgO has high refractoriness and good resistance to basic slags. Minimizing the total impurities content in magnesias is quite important because impurities affect refractoriness and performance. A high CaO/SiO<sub>2</sub> ratio, preferably 2:1 or slightly higher, is optimum for maintaining high refractoriness in magnesias. As the total impurities are reduced to about 1% or less, the CaO/SiO<sub>2</sub> ratio has less and less significance. High density reduces infiltration and dissociation of magnesia grain by slag. Large crystallite size (best achieved in fused magnesias) provides less surface area for slag attack. Low B<sub>2</sub>O<sub>3</sub> content ensures high strength at elevated temperatures for burned brick. Low lime to SiO<sub>2</sub> ratios are required in certain products where MgO is used with other raw materials (such as Cr<sub>2</sub>O<sub>3</sub>) or for maximum resistance to hydration.

### 3.1.1.2 Dolomite

The natural double carbonate dolomite (CaCO<sub>3</sub>·MgCO<sub>3</sub>) can be converted to refractory dolomite (CaO·MgO) by high temperature firing. A limited number of dolomite deposits exists in the world with satisfactory uniformity, purity, and calcining behavior to be processed into high purity, refractory dolomite at a reasonable cost. High purity dolomite is greater than 97% CaO + MgO and

0.5–3% impurities. Most high purity dolomite deposits are difficult to calcine and sinter to high density and usually require special methods to yield acceptable refractory grade dolomite. Silica, iron oxide and alumina are the most common impurities in high purity dolomite. See Table 3.5.

**Table 3.5 Chemical and Physical Properties of High Purity, Dead-Burned Dolomite**

Chemical Analysis (wt%)		Physical Properties	
Al <sub>2</sub> O <sub>3</sub>	0.45	Bulk Density (kg/m <sup>3</sup> )	3250
Fe <sub>2</sub> O <sub>3</sub>	0.90	Closed pore volume (%)	1.3
SiO <sub>2</sub>	0.70		
MgO	41.20		
CaO	56.70		

From Ref. 2.

Dolomite has excellent refractoriness and is thermodynamically very stable in contact with steel or steelmaking slags. Note in Table 3.6 that CaO is the most stable of the common refractory oxides at steelmaking temperatures.

**Table 3.6 The Free Energies of Formation for Various Refractory Oxides**

	$\Delta G @ 1600^{\circ}\text{C}$ ( $\frac{\text{Kcal}}{\text{mole O}_2}$ )
2 Ca + O <sub>2</sub> = CaO	-205
$\frac{2}{3}$ Al + O <sub>2</sub> = $\frac{2}{3}$ Al <sub>2</sub> O <sub>3</sub>	-175
2 Mg + O <sub>2</sub> = 2 MgO	-170
Si + O <sub>2</sub> = SiO <sub>2</sub>	-140
$\frac{2}{3}$ Cr + O <sub>2</sub> = $\frac{2}{3}$ Cr <sub>2</sub> O <sub>3</sub>	-110

From Ref. 2.

The free lime portion of the dead burned dolomite can react with atmospheric moisture which causes the material to powder and crumble. The degree of hydration under set conditions of time, temperature, and relative humidity is dependent upon the proportion of lime and impurities contained in the material and upon the density of the grain achieved during the dead burning process.

In practice, with modern packaging materials and techniques together with other means of protecting the products, the storage of dolomite products can be extended.

### 3.1.2 Magnesita–Chrome Group

Chrome ores, or chromites, often called chrome enriched spinels, are naturally occurring members of the spinel mineral group. These materials are all characterized by relatively high melting points, good temperature stability (particularly in thermal union with magnesite) and moderate thermal expansion characteristics.

Chrome ores are covered by the formula (Mg•Fe<sup>+2</sup>) (Cr,Al,Fe<sup>+3</sup>)<sub>2</sub>O<sub>4</sub>, where magnesium can substitute for iron, and aluminum for chromium. Accessory minerals, called gangue, are often associated with these ores. Gangue minerals contribute residual silica, lime and additional magnesita to the chrome ore. Control, placement and quantity of gangue minerals is as important to finished refractory properties as the basic chemical composition of the individual ore. Ores are often upgraded by mechanical separation techniques to minimize impurities. Thus, chrome concentrates with low gangue impurities, as shown in Table 3.7, are often the article of commerce used in refractories.

Pure Cr<sub>2</sub>O<sub>3</sub> chemically separated from chromite can be used in combination with lower cost oxides to produce specific refractory properties.

In addition to basic refractory raw materials composed of dead burned magnesita and chrome ore as starting materials, other magnesite-chrome combinations are also a part of this series. A magnesite-chrome group of raw materials exists, including co-sintered magnesite-chrome, fused magnesite-chrome and synthetic picrochromite—a combination of magnesite and chromic oxide. Typical magnesite-chrome combinations appear in Table 3.8.

**Table 3.7 Examples of Refractory-Grade Chrome Ores (typical data)**

Source	Philippines –10 concentrates	South Africa	Turkey
<b>Typical Chemistry</b>			
Silica (SiO <sub>2</sub> )	3.20%	0.70%	3-4%
Alumina (Al <sub>2</sub> O <sub>3</sub> )	28.10	14.80	20-21
Iron Oxide (Fe <sub>2</sub> O <sub>3</sub> )	15.20	28.60	15-16
Lime (CaO)	0.28	0.05	0.30
Magnesia (MgO)	17.80	10.80	18.00
Chromic Oxide (Cr <sub>2</sub> O <sub>3</sub> )	35.00	47.10	41.42
Size	12% min. +14 mesh 20% max. –65 mesh	–20+150	–10+100 or Lump
Structure	Hard, Massive	Friable	

From Ref. 3.

**Table 3.8 Examples of Magnesite-Chrome Raw Materials (typical data)**

Source	U. Kingdom Co-Sintered	South Africa Fused Mag. Chrome	Canada/U.S. Fused Mag. Chrome
<b>Typical Chemistry</b>			
Silica (SiO <sub>2</sub> )	1.15%	1.60%	1.2%
Alumina (Al <sub>2</sub> O <sub>3</sub> )	5.70	7.20	6.1
Titania (TiO <sub>2</sub> )	0.20	0.20	0.3
Iron Oxide (Fe <sub>2</sub> O <sub>3</sub> )	12.50	10.70	13.0
Lime (CaO)	0.80	0.60	0.4
Magnesia (MgO)	61.50	59.90	60.1
Chromic Oxide (Cr <sub>2</sub> O <sub>3</sub> )	18.00	18.80	18.6
Bulk Specific Gravity (g/cm <sup>3</sup> )	3.53	3.75	3.8

From Ref. 3.

**Table 3.9 Examples of Refractory-Grade Silicas (typical data)**

Type	Natural Silica (Quartzite)	Fused Silica
<b>Typical Chemistry</b>		
Silica (SiO <sub>2</sub> )	99.70%	99.60%
Alumina (Al <sub>2</sub> O <sub>3</sub> )	0.09	0.20
Titania (TiO <sub>2</sub> )	0.01	—
Iron Oxide (Fe <sub>2</sub> O <sub>3</sub> )	0.09	0.03
Lime (CaO)	0.03	0.04
Magnesia (MgO)	0.01	
Total Alkalies	0.02+	0.01
Bulk Specific Gravity (g/cm <sup>3</sup> )	2.33	2.20
<b>Major Minerals</b>		
Quartz	X	
Vitreous or Glassy		X

From Ref. 3.

## 3.1.3 Siliceous Group

### 3.1.3.1 Natural

Natural silica occurs primarily as the mineral quartz. Heat treatment of silica in the manufacture of refractory products can result in the formation of a number of different crystalline forms. Depending on the thermal history applied, silica refractories may contain various mineral assemblages of quartz, cristobalite, and tridymite. Silica raw materials used in the manufacture of conventional silica refractories, as shown in Table 3.9, must contain high silica (99% or above SiO<sub>2</sub>) and low impurity levels, particularly alumina and alkalies, which can act as fluxes during firing of the refractory and reduce overall refractoriness of the end product.

### 3.1.3.2 Fused Silica

Fused silica is produced by actual fusion of specially selected, very high grade silica sands in electric arc, electrical resistance, or other furnace procedures. Crystalline raw material is converted into an amorphous glass, or fused silica. Properties of this fused raw material vary considerably from those of the original quartz sand, in particular fused silica has very low thermal expansion. Fused silica products exhibit low thermal conductivity, high purity and excellent resistance to thermal shock.

### 3.1.3.3 Silicon Carbide

Commercial silicon carbide (SiC) used as a refractory raw material is manufactured by abrasive grain producers in electric furnaces from a mixture of coke and silica sand. The finished material is extremely hard (9.1 MOH's scale) with high thermal conductivity and good strength at elevated temperatures, as well as very good resistance to thermal shock. Silicon carbide dissociates at 2185°C (3965°F) and oxidizes slowly in air, but is relatively stable under reducing conditions. The material is serviceable at 1535–1650°C (2800–3000°F) for many applications. Table 3.10 shows some analysis of refractory grade silicon carbides.

**Table 3.10 Examples of Refractory-Grade Silicon Carbides**

Type	Coarse, 6/F Low Iron	200/F Low Iron	10/F
Typical Chemistry (Dry Basis)			
Silica (SiO <sub>2</sub> )	3.50%	1.90%	2.40%
Alumina (Al <sub>2</sub> O <sub>3</sub> )	0.50	0.40	0.76
Titania (TiO <sub>2</sub> )	0.05	0.06	0.07
Iron Oxide (Fe <sub>2</sub> O <sub>3</sub> )	0.24	0.45	0.93
Lime (CaO)	0.12	0.20	0.49
Magnesia (MgO)	0.02	0.03	0.29
Alkalies	<0.04	<0.04	—
Silicon Carbide (SiC)	94.90	96.80	91.70
Total Carbon	29.10	29.20	30.70
Free Carbon	0.60	0.30	3.20

From Ref. 3.

### 3.1.3.4 Zircon/Zirconia

Zircon, or zirconium silicate (ZrO<sub>2</sub>•SiO<sub>2</sub>), is a naturally occurring raw material having excellent refractoriness. Specific gravity (4.5–4.6 g/cm<sup>3</sup>) is unusually high compared to most refractory materials.

Major zircon sources include the natural sands of western Australia, eastern Florida, South Africa's northern Natal east coast, the European Economic Community countries and the Peoples Republic of China. Zircon usually is found with other heavy mineral sands, most notably titania minerals. Table 3.11 shows properties of zircon.

Zirconium oxide (ZrO<sub>2</sub>) is produced commercially as the naturally occurring mineral baddeleyite. The refractory industry has been a major growth area for zirconia. The relatively high melting point of baddeleyite, along with superior resistance to corrosion and erosion, make zirconia an ideal component for several refractory systems. Zirconia in the natural state occurs in the monoclinic crystal phase. When heated, zirconia undergoes a phase change (to tetragonal) and a volume shrinkage of about 5%; with additional increases in temperature, the cubic form is stable at 2350°C (4260°F). To counteract these deleterious phase changes, zirconia may be stabilized to the cubic phase with small amounts of calcia, magnesia, or yttria, with the result that stability, thermal shock

**Table 3.11 Refractory-Grade Zircons (typical data)**

Type	Zircon Sand	Zircon -200 Mesh	Zircon -400 Mesh
<b>Typical Chemistry (Calcined Basis)</b>			
Silica (SiO <sub>2</sub> )	32.60%	33.60%	33.70%
Alumina (Al <sub>2</sub> O <sub>3</sub> )	0.80	0.50	0.50
Titania (TiO <sub>2</sub> )	0.20	0.10	0.20
Iron Oxide (Fe <sub>2</sub> O <sub>3</sub> )	0.03	0.02	0.01
Lime (CaO)	0.03	0.03	0.03
Magnesia (MgO)	0.03	0.02	0.02
Zirconia (ZrO <sub>2</sub> )	66.20	65.60	65.60
Screen Analysis			
+200 Mesh	—	2	0
+325 Mesh	—	11	1
+400 Mesh	—	7	5
-400 Mesh	—	79	95

From Ref. 3.

**Table 3.12 Refractory-Grade Zirconia (typical data)**

Type	Baddelevite (natural mineral concentrate)	Zirconia Fused (lime stabilized)
<b>Typical Chemistry (Calcined Basis)</b>		
Silica (SiO <sub>2</sub> )	0.36%	0.37%
Alumina (Al <sub>2</sub> O <sub>3</sub> )	0.01	0.50
Titania (TiO <sub>2</sub> )	0.30	0.31
Iron Oxide (Fe <sub>2</sub> O <sub>3</sub> )	0.20	0.09
Lime (CaO)	0.01	3.98
Magnesia (MgO)	0.05	0.27
Zirconia (ZrO <sub>2</sub> )	99.20	94.46
Soda (Na <sub>2</sub> O)	0.02	0.02
Potash (K <sub>2</sub> O)	<0.01	<0.01
Lithia (Li <sub>2</sub> O)	<0.01	<0.01
Loss on Ignition	0.11	—

From Ref. 3.

resistance, and hot load properties are enhanced in the final product. Zirconia is available in the natural, stabilized, or fused state, the latter often as a mixture with alumina, silica, or other compatible oxides. Table 3.12 shows typical properties of zirconia.

### 3.1.4 Clay and High-Alumina Group

#### 3.1.4.1 Clays

Although clays were among the first raw materials used to make refractories, their usage has diminished as demands placed on modern refractories have necessitated better performing materials to replace them. Nevertheless, clays are still an important material in the industry.

Clays may be used as binders, plasticizers, or as aggregates for producing refractories. The properties of some domestic clays are shown in Table 3.13.

#### 3.1.4.2 Bauxitic Kaolins

Several other types of 50–70% alumina raw materials are also used in refractories. Bauxitic kaolins, or bauxite clay combinations, represent another class of natural aluminum silicates used in refractory manufacture. Major U.S. commercial deposits of aluminous refractory raw materials are found in southeastern Alabama, and in east-central Georgia. These materials, shown in Table 3.14, are mined, blended and fired in rotary kilns to yield a versatile line of calcined aluminum silicates, ranging from about 50% to over 70% alumina content.



**Table 3.13 Some Examples of Refractory Clays (typical data)**

Locale Type	Missouri Flint	Missouri Plastic	Kentucky Mine Run	Georgia Kaolin	Ball Clay	Bentonite
<b>Typical Chemistry (Calcined Basis)</b>						
Silica (SiO <sub>2</sub> )	50.0%	59.5%	51.4%	52.1%	62.5%	67.7%
Alumina (Al <sub>2</sub> O <sub>3</sub> )	45.3	32.3	42.5	44.5	31.4	20.4
Titania (TiO <sub>2</sub> )	2.4	1.6	2.6	1.8	1.5	0.2
Iron Oxide (Fe <sub>2</sub> O <sub>3</sub> )	0.8	2.2	1.8	0.6	2.5	4.5
Lime (CaO)	0.2	0.4	0.2	0.3	0.5	1.1
Magnesia (MgO)	0.2	0.8	0.5	0.1	0.7	2.3
Alkalies (total)	0.6	3.1	1.4	0.3	0.7	3.5
L.O.I. (dry basis)	—	8.3	12.7	13.7	10.3	5.4
B.S.G. (g/cm <sup>3</sup> )	2.57–2.62					
Bulk Density (Pcf)	148	130	143	—	—	—
Linear Change, after Cone 15 (in/ft.)	0.5–1.1	0.75–1.25	0.75–1.0	—	—	—
PCE (Cone)	34+	29–31	32½–33	34+	31½	13+

From Ref. 3.

**Table 3.14 Domestic U.S. Bauxitic Kaolins**

Typical Chemistry	Ucal 50	Ucal 60	Ucal 70
Silica (SiO <sub>2</sub> )	47.30%	36.90%	25.70%
Alumina (Al <sub>2</sub> O <sub>3</sub> )	49.20	59.20	70.00
Titania (TiO <sub>2</sub> )	2.40	2.60	3.20
Iron Oxide (Fe <sub>2</sub> O <sub>3</sub> )	1.00	1.10	1.00
Lime (CaO)	0.02	0.02	0.02
Magnesia (MgO)	0.04	0.05	0.04
Alkalies (total)	0.08	0.11	0.07
Specific Gravity (g/cm <sup>3</sup> )	2.60	2.70	2.78
Pyrometric Cone Equivalent	35–36	37–38	38–39

From Ref. 3.

### 3.1.4.3 Sillimanite

Andalusite, sillimanite and kyanite comprise the water-free, natural aluminum silicate varieties of minerals known as the sillimanite group. Andalusite and kyanite are the more common commercial materials. These minerals are normally about 60% alumina, with the balance composed primarily of silica with minor iron and titania impurities, Table 3.15. Andalusite and sillimanite have several important characteristics; when heated at high temperatures, the refractory mineral mullite (3Al<sub>2</sub>O<sub>3</sub>·2SiO<sub>2</sub>) is formed. Complete mullite occurs at 1300–1400°C (2372–2552°F). This mineral is a key component of many high-alumina materials.

### 3.1.4.4 Bauxite

Bauxite in the crude state is a naturally occurring group of minerals composed primarily of either gibbsite (Al<sub>2</sub>O<sub>3</sub>·3H<sub>2</sub>O), diaspore, or boehmite [AlO(OH)], and various types of accessory clays. Refractory grade calcined bauxites are a specific form as found in Table 3.16. These are produced from low iron, low silica materials in rotary kiln calcining operations or down-draft kilns. Calcining temperatures are in the 1400–1800°C (2550–3275°F) range. Crude bauxite is converted to the

**Table 3.15 Examples of Andalusite and Kyanites**

Source	S. Africa A	Andalusite S. Africa B	French A	Kyanite United States
<b>Typical Chemistry</b>				
Silica (SiO <sub>2</sub> )	38.00%	38.10%	43.80%	39.90%
Alumina (Al <sub>2</sub> O <sub>3</sub> )	60.30	61.90	53.00	56.00
Titania (TiO <sub>2</sub> )	0.17	0.16	0.25	1.80
Iron Oxide (Fe <sub>2</sub> O <sub>3</sub> )	0.72	0.59	1.20	1.60
Lime (CaO)	0.11	0.06	0.20	0.04
Magnesia (MgO)	0.09	0.11	0.15	0.04
Soda (Na <sub>2</sub> O)	0.06	0.06	0.20	
Potash (K <sub>2</sub> O)	0.22	0.13	0.20	0.16 total
Lithia (Li <sub>2</sub> O)	0.02	0.01	—	
L.O.I. (dry Basis)	0.44	0.28	0.08	0.90
Screen Analysis				
+6 Mesh	17%	77%		35 mesh or
-6 +10 Mesh	34	14		100 mesh ×
-10 +16 Mesh	44	9		down
-16 Mesh	5	—		

From Ref. 3.

**Table 3.16 Refractory-Grade Calcined Bauxites (typical data)**

Source	Guyana, S.A.	China	Brazil	United States (Diaspore)
<b>Typical Chemistry (Calcined Basis)</b>				
Silica (SiO <sub>2</sub> )	6.50%	5.60%	9.0–10.0%	16.8%
Alumina (Al <sub>2</sub> O <sub>3</sub> )	88.00	87.50	85.0–87.0	75.7
Titania (TiO <sub>2</sub> )	3.25	3.64	1.9–2.3	3.8
Iron Oxide (Fe <sub>2</sub> O <sub>3</sub> )	2.00	1.56	1.6–2.1	0.9
Lime (CaO)	0.02	0.06	<0.2	0.3
Magnesia (MgO)	0.02	0.17	<0.2	0.5
Alkalies (total)	0.01	0.62	<0.1	2.3
Loss in Ignition	0.25	trace	<0.1	trace
Bulk Specific Gravity (g/cm <sup>3</sup> )	3.10 min.	3.20	3.15–3.20	2.74

From Ref. 3.

minerals corundum (Al<sub>2</sub>O<sub>3</sub>) and mullite (3Al<sub>2</sub>O<sub>3</sub>•2SiO<sub>2</sub>) — both very refractory components. Important features of bauxites are maximum alumina values (85% or more desired), maximum bulk specific gravity, and minimum impurities such as iron oxide, titania, alkalies (Na<sub>2</sub>O, K<sub>2</sub>O and Li<sub>2</sub>O) and alkaline earths (CaO and MgO). Major sources for calcined, refractory grade bauxite are Guyana, South America, and the Peoples Republic of China.

### 3.1.5 Processed Alumina Group

Several types of chemically and thermally processed aluminas are used in refractories. These include calcined, tabular, and fused alumina all from the Bayer process as illustrated in Fig. 3.2 and Fig. 3.3.

In general, calcined aluminas are used to promote refractory binding during manufacture or use whereas tabular or fused products form very stable aggregates. Tabular alumina is formed by calcination at 1925°C (3500°F), whereas fused alumina is more dense after total melting and rapid solidification. Tables 3.17 through 3.19 show properties of these alumina grades.

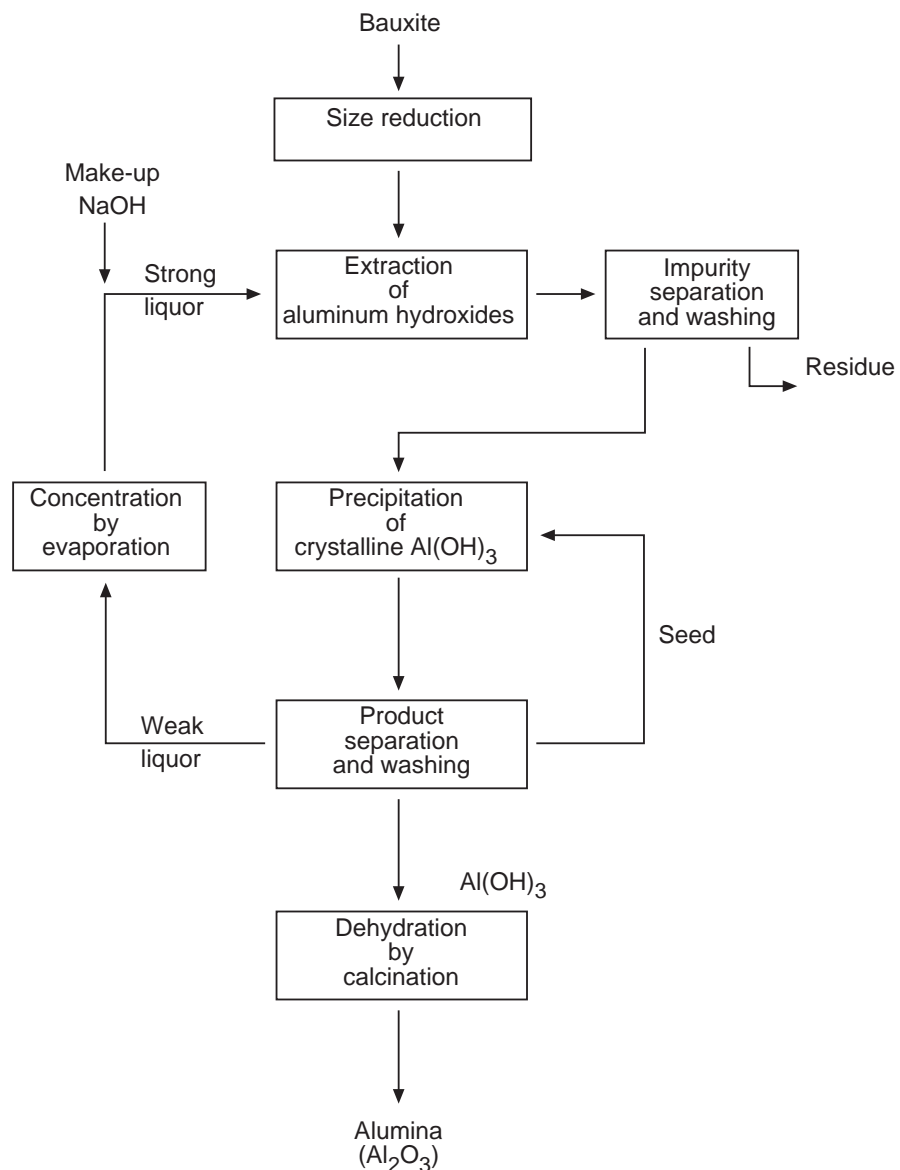


Fig. 3.2 Schematic of Bayer process.

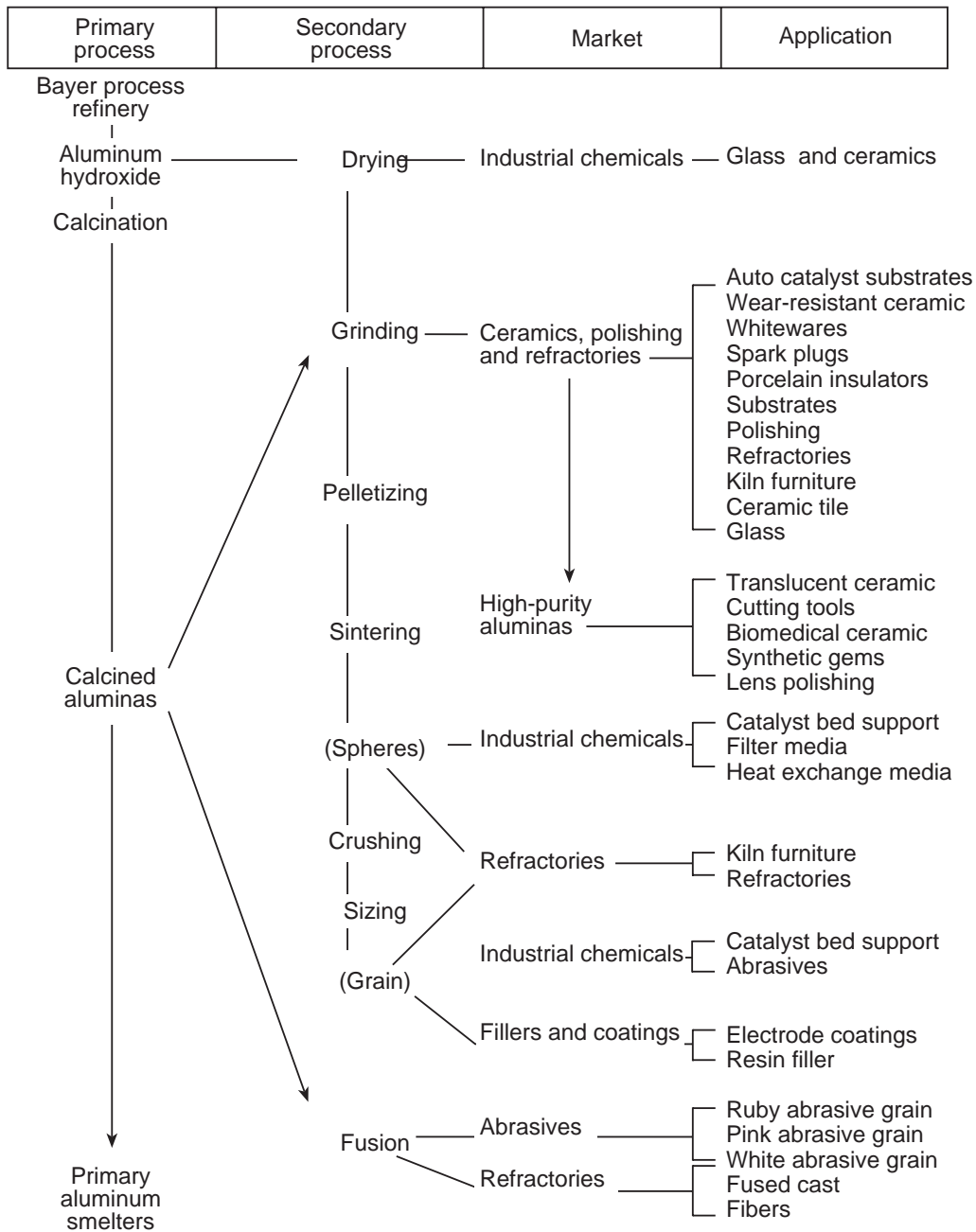


Fig. 3.3 Products of Bayer Process.

### 3.1.6 Carbon Group

Various carbon forms are used to an ever increasing extent in refractories. For example, modern refractories use various graphite forms in combination with oxides to impart special properties. The graphite may be synthetic in nature as produced by heating calcined petroleum coke to 3000°C (5400°F) or may be natural graphite(s) from China, Mexico, Canada etc. Some all-carbon or all-graphite refractories may be produced for applications in highly reducing atmospheres.

**Table 3.17 Calcined Aluminas (typical data)**

Source	Hydrated	Intermediate Soda Calcined A	Intermediate Soda Fine Ground Calcined B	Low Soda Super Ground Calcined C
<b>Typical Chemistry</b>				
Silica (SiO <sub>2</sub> )	0.01%	0.03%	0.05%	0.04%
Alumina (Al <sub>2</sub> O <sub>3</sub> )	65.00	99.40	99.80	99.70
Titania (TiO <sub>2</sub> )	—	0.03	0.01	<0.01
Iron Oxide (Fe <sub>2</sub> O <sub>3</sub> )	0.004	0.04	0.02	0.04
Lime (CaO)	—	0.06	0.20	0.04
Magnesia (MgO)	—	0.02	0.03	0.01
Total Alkalies (Na <sub>2</sub> O)	0.15	0.19	0.23	0.08
Loss on Ignition (LOI)	34.50	0.21	0.10	0.03
Ultimate Crystal Size.(μm)	—	3 to 5	—	1.50
Surface Area (m <sup>2</sup> /g)	0.15	0.50	—	1.00

From Ref. 3.

**Table 3.18 Tabular Alumina (typical data)**

Source	United States	United States
<b>Typical Chemistry</b>		
Silica (SiO <sub>2</sub> )	0.04%	0.04%
Alumina (Al <sub>2</sub> O <sub>3</sub> )	99.70+	99.80+
Titania (TiO <sub>2</sub> )	0.01	0.01
Iron Oxide (Fe <sub>2</sub> O <sub>3</sub> )	0.06	0.03
Lime (CaO)	0.04	0.01
Magnesia (MgO)	<0.001	0.02
Boron Oxide (B <sub>2</sub> O <sub>3</sub> )	<0.001	—
Soda (Na <sub>2</sub> O)	0.16	0.05
Bulk Specific Gravity (g/cm <sup>3</sup> )	3.55	3.54

From Ref. 3.

**Table 3.19 Fused Aluminas (typical data)**

Typical Chemistry	Brown <sup>1</sup>	White <sup>2</sup>	White <sup>3</sup>
Silica (SiO <sub>2</sub> )	0.40%	0.04%	0.14%
Alumina (Al <sub>2</sub> O <sub>3</sub> )	96.70	99.50	99.41
Titania (TiO <sub>2</sub> )	2.52	—	<0.01
Iron Oxide (Fe <sub>2</sub> O <sub>3</sub> )	0.10	0.10	0.02
Lime (CaO)	0.05	0.05	0.02
Magnesia (MgO)	0.18	—	0.02
Soda (Na <sub>2</sub> O)	0.10	0.30	0.39
Potash (K <sub>2</sub> O)	—	—	0.01
Bulk Specific Gravity (g/cm <sup>3</sup> )	3.75	3.77	3.50*

<sup>1</sup> General Abrasives – Treibacher, Inc.    <sup>2</sup> Washington Mills    <sup>3</sup> C.E. Minerals    \* bulk density

From Ref. 3.

Generally, graphites are used in refractories in order to reduce the wetting characteristics of the refractory material with respect to slag corrosion and to increase the thermal conductivity which will result in better thermal shock resistance. In oxide-carbon refractories, the carbon content may range anywhere from as low as 4–5% up to as high as 30–35%. Note that as the graphitic content increases, the thermal conductivity of the refractory increases, but the density of the refractory decreases. This result is primarily due to the fact that the density of graphite is much less than the density of the other refractory materials being used. There are other contrasting differences in the morphology of the graphite as compared to the other refractory materials. The graphite materials, which are used in refractories, are commonly of a flaky structure; therefore, these flakes do not lend themselves to the same particle packing phenomena as do granular particles.

Table 3.20 shows the properties of several types of graphite. Flake graphite is commonly purified to extremely high carbon contents of 99 wt% carbon or higher. This purification utilizes both a chemical process and a thermal process; these steps have a significant effect on the price of the materials.

**Table 3.20 Typical Properties of Graphite**

	Amorphous	Flake	High crystal-line	Primary artificial	Secondary artificial
Carbon (wt%)	81.00	90.00	96.70	99.90	99.00
Sulfur (wt%)	0.10	0.10	0.70	0.001	0.01
True Density (kg/m <sup>3</sup> )	2310	2290	2260	2250	2240
Graphite Content (wt%)	28.0	99.9	100.0	99.9	92.3
d-spacing (002) (nm)	33.61	33.55	33.54	33.55	33.59
Ash True Density (kg/m <sup>3</sup> )	2680	2910	2890	2650	2680
Resistivity (ohm-m)	0.00091	0.00031	0.00029	0.00035	0.00042
Morphology	Granular	Flaky	Plates Needles Granular	Granular	Granular

From Ref. 2.

## 3.2 Preparation of Refractories

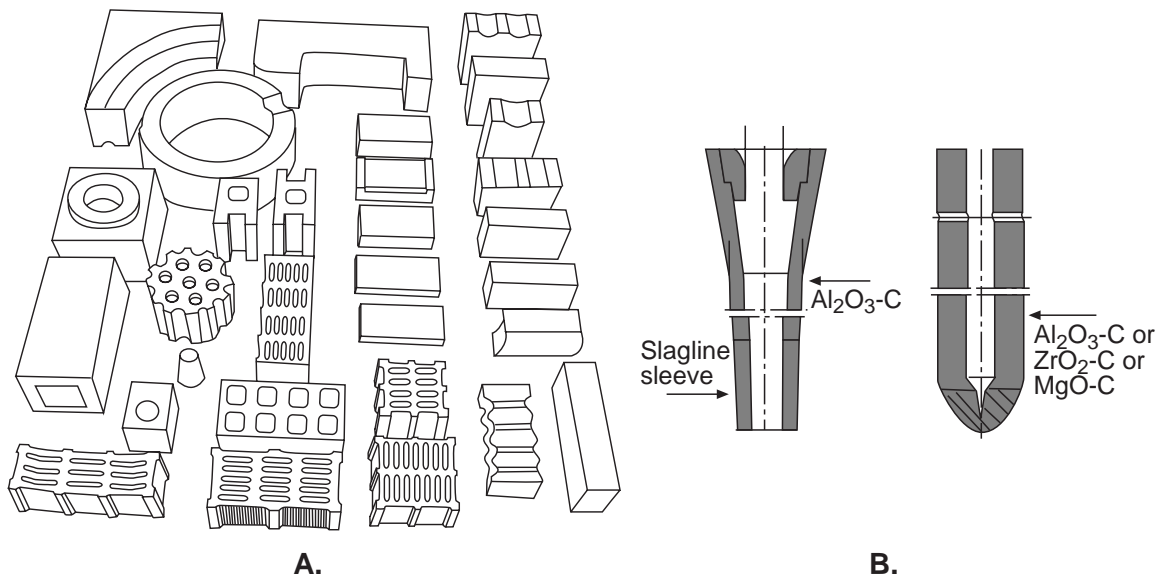
### 3.2.1 Refractory Forms

Refractories are produced in two basic forms: preshaped objects and unformed compositions in granulated, plastic forms or spray mixes. The preformed products are called bricks and shapes. The unformed products, depending on composition and application, are categorized as specialties or monolithics. Refractory shapes, found in Fig. 3.4, may range from simple nine inch brick to tapered 30 inch brick, or complex tubes or rods.

Specialties or monolithics are refractories that cure to form a monolithic, integral structure after application. These include products known as plastics, ramming mixes, castables, pumpables, pourables, spray mixes, gunning mixes and shotcreting. The mortars used to install brick and shapes constitute a category of the specialty refractory classification.

Mortars are available in compositions that either approximate the brick they are bonding together, or are chosen so that their thermal expansion will be similar to the brick with which they are used. The goal is to achieve a lining that comes as close as possible to being a monolithic and continuous refractory structure.

As the name implies, plastic refractories are ready-to-use materials that are installed by tamping or ramming. After drying, either the heat from firing the equipment or a chemical binder converts the plastic material to a solid, monolithic structure. Plastic refractories are available in both clay and nonclay compositions.



**Fig. 3.4** A. Bricks and shapes; B. more complex tubes and rods.

Castables, or refractory concretes, are predominately dry, granular refractory mixes designed to be mixed on site with water and capable of curing to a stable dimensional form through hydraulic or chemical setting. Castables are particularly suited to the molding of special shapes and parts at the installation site. They can be used for forming complete furnace linings, and other unique shapes. They can be applied by pouring, pumping, troweling, gunning, and shotcreting. They have the advantage of being readily usable at the operating temperature of the equipment after hydraulic or chemical setting and removal of all moisture has taken place.

Spray mixes are made from a variety of refractory compositions. The common feature of these materials is that they contain sufficient water for transport via pumps and for spray application onto a furnace wall or ceiling. A set accelerator is added in sufficient quantity such that the mix sets rapidly.

Gunning mixes comprise a variety of specialty refractory compositions that develop a solid shape by air drying, hydraulic setting, or heat curing. The principal requirements are that they can be blown into position by air pressure through a lance or nozzle, but must adhere on impact and build up to the desired lining thickness. They are used for patch-type repairs, especially inside empty, hot furnaces.

Fig. 3.5 is a greatly simplified flowsheet illustrating the various methods of refractory manufacture and the resultant products, and classifies raw materials as either calcined, uncalcined (raw), or binders. Calcined materials have been fired to remove moisture and volatiles and to densify the material to minimize subsequent in-service shrinkage and reaction. The calcining temperature will range from 1093–3315°C (2000–6000°F). Raw or uncalcined materials are cheaper to use than calcined materials and are used to impart desirable characteristics such as plasticity or volume expansion to certain refractories. Binders are used to impart strength to the refractory during manufacture or in service.

## 3.2.2 Binder Types

### 3.2.2.1 Temporary Binder

Temporary binders include paper byproducts, sugar, or certain clays. Their function is to improve handling strength during manufacture.

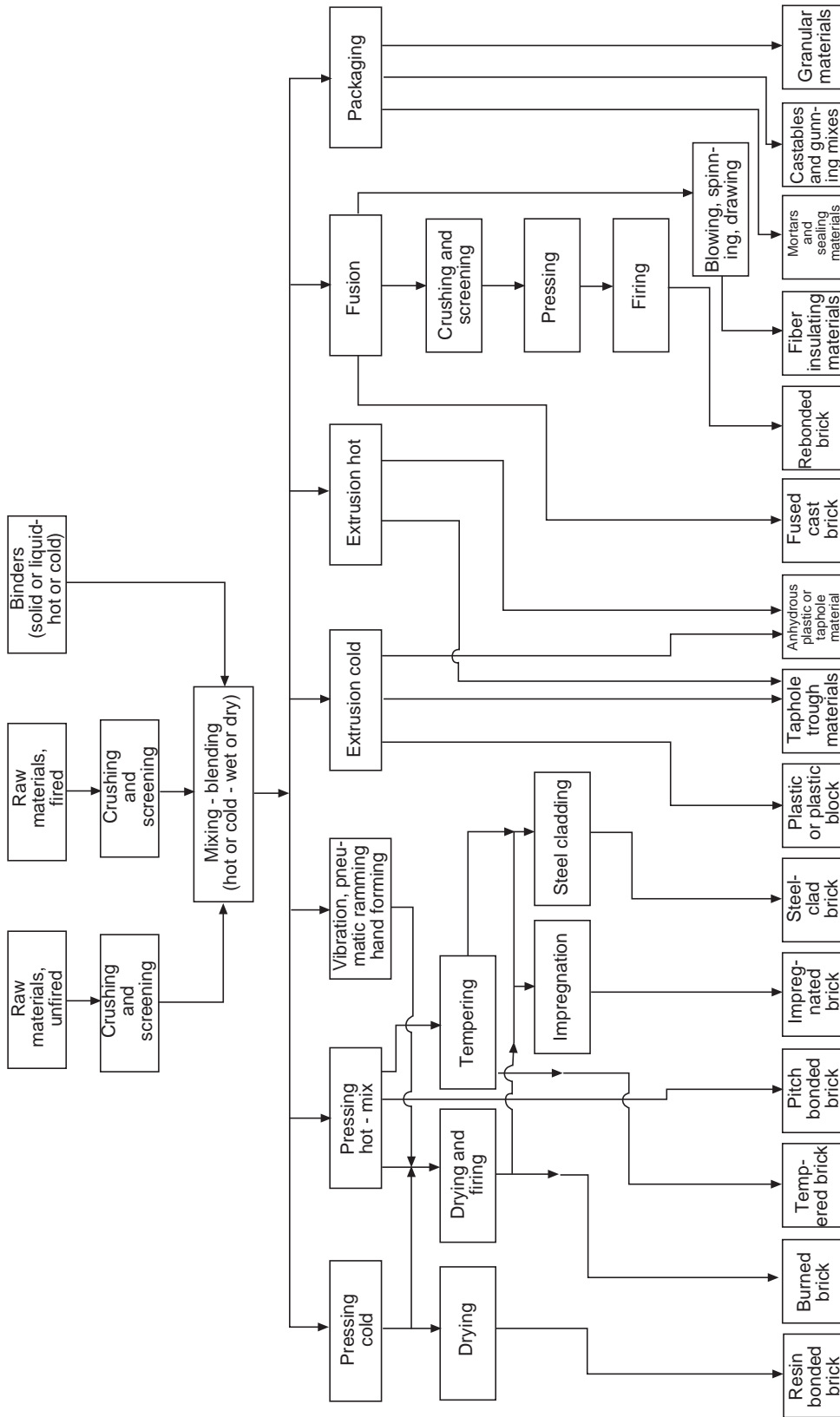


Fig 3.5 Simplified flowsheet for refractory materials.



**Table 3.21 Dry Binder Ingredients for Ramming Mixes, Plastics and Patching Plasters**

Boric Acid
Colloidal Aluminas
Colloidal Silicas
Goulac
Hydrated Aluminas
Methyl Cellulose
Mono-Aluminum Phosphates
Petroleum Pitches
Resins
Silica Fume
Sodium Aluminum Phosphates
Sodium Poly Phosphates
Sodium Silicate
Starches
Synthetic Clays
Waxes

### 3.2.2.2 Chemical Binders

Chemical binders impart strength during manufacture, after manufacture, or on installation as a monolithic material. Tables 3.21 and 3.22 show some of the binders which might be used for monolithic materials depending on the application and properties desired.

### 3.2.2.3 Cement Binders

Cement binders set hydraulically when mixed with water. The primary binders of this type used in refractories are the calcium-aluminate cements which set rapidly and are able to retain some of their bonding strength to intermediate temperatures. The cement(s) used in refractories are  $\text{CaO}\cdot\text{Al}_2\text{O}_3$  type cements which develop strength more rapidly than portland cements (near maximum strength in one day as opposed to 7–10 days) and are capable of retaining strength to higher temperatures than Portland cements. Table 3.23 shows several grades of refractory cements.

**Table 3.22 Liquid Binder Ingredients for Ramming Plastics and Patching Mixes**

Aqueous	Non-Aqueous
Alginates	Coal Tars
Chromic Acid	Oils
Colloidal Silica Solution	Petroleum Tars
Glutrin Resins	
Mono Aluminum Phosphates	
Molasses	
Phosphoric Acids	
Potassium Silicates	
Resins	
Sodium Aluminum Phosphates	
Sodium Silicates	
Water	

### 3.2.2.4 Organic Binders

Organic binders include tars, pitches, or resins for use in reducing atmospheres where the carbon residuals impart bonding strength or act to inhibit alteration.

The coal tar pitches, derived as by-products of coke oven operation, were the preferred binders for refractories up to the mid 1970s. Around 1978, transition was made from coal tar to petroleum pitches. Today most organic binders are resin based so they can be processed cold to minimize environmental problems.

**Table 3.23 Chemical Composition of Calcium-Aluminate Cements**

	A	B	C	D	E
$\text{Al}_2\text{O}_3$	39.0	47.0	58.5	72.5	79.0
$\text{TiO}_2 + \text{Fe}_2\text{O}_3$	17.8	7.4	1.7	0.25	0.3
CaO	38.5	34.3	33.5	26.0	18.0
$\text{SiO}_2$	4.5	7.9	5.2	0.35	0.2
MgO	1.0	0.9	0.1	—	0.4
Alkalies + $\text{SO}_3$	0.25	2.1	0.4	0.4	0.5

Phenolic resins, the most important synthetic binders for refractory materials, are condensation products of phenol and formaldehyde. These resins are differentiated according to whether they represent novolacs or self curing resoles. The versatility of phenolic resins is derived from the various bonding functions that they can provide. Among other things phenolic resins can provide an intermediate bonding function associated with a thermosetting range of properties during production of refractory bricks and, at a later stage, are capable of forming (polymeric) carbon by pyrolytic decomposition. In the form of bonding carbon, these results contribute to the quality of the products.

### 3.2.3 Processing

A knowledge of the various steps in refractory processing is very important in understanding the behavior of steelplant refractories. As shown in Figure 3.5, all refractories use crushing, sizing and mixing or blending as the first steps in their manufacture. These steps produce the proper particle sizings necessary for the desired product density and strength. In sizing a mix to produce dense brick, for example, the raw materials are crushed and screened to produce some desired particle size range as illustrated below:

Screen Size		
mm	Tyler Mesh Size	wt% of Mix
4.6 through 1.65	4 through 10	20
1.65 through 1.17	10 through 14	30
1.17 through 0.83	14 through 20	5
0.83 through 0.30	20 through 48	5
0.30 through 0.15	48 through 100	5
0.15 through 0.07	100 through 200	5
0.07 through 0.04	200 through 325	10
Below 0.04	Below 325	20

The crushing and screening techniques used are increasingly complex, including vibratory screening equipment and air classification techniques.

Mixing and blending steps range from the simple addition of water to clay, to hot mixing of preheated aggregates with selected resin or other anhydrous binders. Special sequences of combining raw materials, the time of mixing, and the

use of high energy mixing equipment are used to obtain uniform mixing and equal distribution of additives.

Fig. 3.5 illustrates some (but not all) of the forming methods that are used after mixing and blending. The most widely used manufacturing method involves cold pressing of the grain-sized and blended mix to produce a dense refractory shape. Power or dry pressing of the mix into a shape is done on hydraulic or mechanical presses capable of forming the moist material (2–5% water) at pressures of 34.5 to 103.4 MPa (5 to 15 ksi). The degree of compaction obtained in this pressure range depends on plasticity and particle sizing, but most high quality brick are pressed to the point where further pressure would produce laminations or internal cracking. The pressing chamber or mold may be evacuated or de-aired to increase density and prevent laminations resulting from entrapped air. Dry pressing lends itself to a wide variety of materials and can produce a wide range of properties. Certain products may be pressed hot and these materials are usually plasticized with liquid pitch.

Shapes may also be formed by applying pressure by other means such as vibration, pneumatic ramming, hand molding, or isostatic pressing. Many brick and special shapes in fire clay compositions are also formed by extrusion followed by low pressure pressing (the stiff mud repress process). In this process, more plastic mixes (10–15% water) are forced through a die by a power driven auger, cut into slugs, and then pressed to shape. This process usually involves de-airing during extrusion.

Hot extrusion of pitch or other anhydrous bonded materials may also be used; however, this is mainly for monolithic materials.

In limited cases, raw materials are fused in very high temperature electric furnaces and cast into larger ingots in graphite molds. These ingots can subsequently be cut to the desired shape, or may

be broken and crushed into a refractory raw material for use in conventional powder pressed brick or for use in monoliths. In still another process, molten refractory may be blown, drawn, or spun into fibers for subsequent use in forming mats, blankets, or boards.

Many refractory materials are used in bulk form. Sized, granular refractories may be used in dry form or mixed with water at the plant site before installation by casting or gunning. Wet extruded material may be packaged to avoid drying and shipped to the plant site ready for application by ramming into place as a large monolithic structure. Wet bonding mortars may be shipped in sealed containers ready for use.

As shown in Fig. 3.5 many products are prefired before shipment. The purpose of firing is to produce dimensionally stable products having specific properties. Firing in modern refractory plants is accomplished in continuous or tunnel kilns.

In tunnel kiln firing, which is usually preceded by tunnel drying, the unfired brick loaded on small cars are passed slowly through a long tunnel shaped refractory lined structure, divided successively into preheating, firing and cooling zones, generally taking three to five days for the trip. This time will vary widely, however, with the product being fired. Products of combustion from the fuel burned in the firing zone pass into the preheating zone (countercurrent to the direction of travel of the cars onto which the brick are stacked) and give up their heat to the oncoming loads of brick. Some refractories are also fired in batch or periodic kilns where two to four week cycles are used for heating, cooling, and loading and unloading kilns.

Temperatures of firing are important regardless of the type of kiln used, because both the quality and properties of the brick may be affected. The final properties and behavior of most brick can be modified by firing them in an oxidizing or a reducing atmosphere. By controlling the rate of heating and the maximum soaking temperature and soaking time, change in the crystalline structure can be effected, which in turn can also affect the service performance of the brick. In general, the objectives in firing are to (a) drive off hygroscopic, combined water, and  $\text{CO}_2$ ; (b) bring about desired chemical changes such as oxidizing iron and sulfur compounds, and organic matter, etc; (c) effect transformations of the mineral constituents and convert them to the most stable forms; and (d) effect necessary combinations and vitrification of bonding agents. Firing temperatures vary from as low as  $1093^\circ\text{C}$  ( $2000^\circ\text{F}$ ) for certain fireclay materials to over  $1770^\circ\text{C}$  ( $3200^\circ\text{F}$ ) for some basic products.

Certain refractories with carbon binders or containing oxidizable constituents may be indirectly fired inside muffles to prevent oxidation or may be packed in coke or graphite during firing for the same purpose. One grade of carbon refractory is hot pressed by electrically heating it during pressing. This accomplishes the forming and thermal treatment of the refractory in a single step. Nitrogen or other special atmospheres may be used to impart special binding phases such as silicon nitride.

Manufacturing processes for making lightweight or insulating brick aim for high porosity, preferably with a fine pore structure. This is accomplished by mixing a bulky combustible substance, like sawdust or ground cork, or volatile solid, such as naphthalene, with the wet batch, by forcing air into the wet plastic mass, or by mixing into the batch reagents which will react chemically to form a gas and a product not injurious to the brick. In firing such brick, the combustible or volatile material is eliminated and the remaining refractory structure is rigidized. Low density, pre-expanded aggregate may also be used to make products by conventional brickmaking methods.

Some processing after the fired brick are produced may also be performed. For example the brick may be steelcased for use in applications where oxidization of the steel case between brick serves to weld or hold the brick together. Many brick types are also impregnated by placing the fired brick into vacuum tanks and introducing liquid pitch or resins into the brick pore structure. This treatment results in formation of a carbon phase in service which has highly beneficial effects in some applications.

### 3.2.4 Products

With the large number of raw material types, refractory forms, and manufacturing techniques a multitude of refractory products are produced. A significant number of them are currently used in the iron and steel industry. This chapter and the one that follows will present considerable more detail regarding the specific uses of refractories.

### 3.3 Chemical and Physical Characteristics of Refractories and their Relation to Service Conditions

The foregoing discussions have indicated that there is a wide variety of refractories from the standpoint of raw materials, overall composition, and method of manufacture. The requirements for refractories are equally diverse. Analysis of service conditions in iron and steelmaking in general shows that refractories are required to withstand:

1. A wide range of temperature, up to 2200°C (4000°F).
2. Sudden changes in temperature; high tensile stresses accompanying these rapid temperature changes cause thermal shock which result in cracking or fracturing.
3. Low levels of compressive stresses at both high and low temperatures.
4. Abrasive forces at both high and low temperatures.
5. The corrosive action of slags, ranging from acidic to basic in character.
6. The action of molten metals, always at high temperatures and capable of exerting great pressures and buoyant forces.
7. The action of gasses, including CO, SO<sub>2</sub>, Cl, CH<sub>4</sub>, H<sub>2</sub>O, and volatile oxides and salts of metals. All are capable of penetrating and reacting with the refractory.
8. As a refractory is being subjected to one or more of the previously stated conditions, it usually functions as a highly effective insulator, or may also be required to be a conductor or absorber of heat depending on its application. The refractory also must perform without exposing workers or environments to unsafe or unhealthy conditions at all times.

As any particular service environment usually involves more than one of the above factors, predetermining the life of a refractory is a complex process involving information on physical and thermal properties as determined by laboratory testing, analysis of the effect of service or process conditions and media on the refractory, and a knowledge of the fundamental reactions between refractories and the various contaminants encountered in service. In this section the physical and chemical characteristics of selected refractories as measured in a variety of laboratory tests will be described as a general guide to understanding the complex nature of these materials in relation to their service environments.

#### 3.3.1 Chemical Composition

As described in the section on refractory classification, the raw materials used in making refractories differ appreciably and result in materials with a wide range of compositions. It must be emphasized that these are unaltered refractories before use and not refractories that have been chemically changed in service. Refractories have the unique ability to withstand alteration by penetration, contamination, and/or reaction in service and still function as reliable engineering materials. Section 3.4 will describe the reactions between refractories and their environments. As a general rule, however, recent trends in refractory development require refractories with the minimum content of impurities, and these impurities are deliberately decreased during raw material or product processing.

Refractory Type	Undesirable Impurities
Silica	Al <sub>2</sub> O <sub>3</sub> alkali TiO <sub>2</sub>
Fireclay—all types	alkali, iron oxide, CaO, MgO
High alumina—all types	SiO <sub>2</sub> , iron oxide, CaO, MgO
Magnesia-chrome—all types	SiO <sub>2</sub> , iron oxide
Magnesia—all types	SiO <sub>2</sub> , Al <sub>2</sub> O <sub>3</sub> , iron oxide
Carbon	alkali, iron oxide

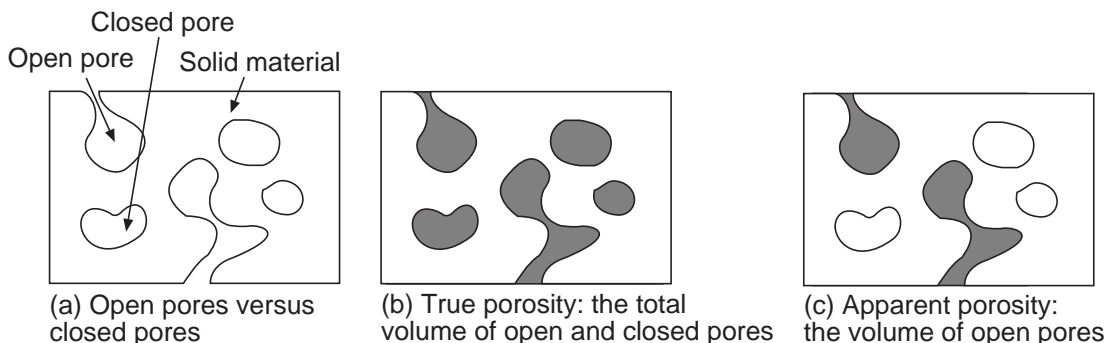
The following describes the undesirable constituents (originally present or from contamination) in several types of refractories. It should be noted that many other impurities (such as PbO, ZnO, B<sub>2</sub>O<sub>3</sub>, etc.) which are undesirable in all refractories because of their low melting points have not been shown.

The importance of composition will be described in Section 3.4 where phase diagrams will be used to indicate the reactions in refractories and their environment at elevated temperatures.

### 3.3.2 Density and Porosity

Refractory density and porosity are among the most misunderstood and yet useful characteristics of steelplant refractories. It must be appreciated that most refractories are not fully dense but deliberately contain both open and closed pores. Fully dense refractory materials with their inherently low tensile strengths can not resist the temperature gradients in normal service at constant temperatures (for example across a wall of a furnace or a tube with steel inside and ambient conditions outside). Refractory materials are also commonly made as heterogeneous structures to promote resistance to thermal cracking. The volume of pores are measured by immersion of a refractory specimen in a liquid or in vacuum. (The measurement of total volume is based on Archimedes' principle that states that a body submerged in a fluid will weigh less than its actual weight by an amount equal to the weight of the displaced fluid. Knowing that difference in weight and the density of the fluid, the volume of the submerged body is easily calculated. The volume of open pores is measured by the amount of liquid absorbed by the sample.)

Fig. 3.6 illustrates the difference between apparent and closed porosity and Fig. 3.7 shows the steps in determining these properties using a vacuum pressure technique. These simple measurements are somewhat useful in comparing like refractory products but most useful as quality control measurements for the consistency of manufacture for a given refractory brand.



**Fig. 3.6** Schematic representation of: (a) open pore, and closed pore, and sample volume for (b) true porosity, and (c) apparent porosity. *From Ref. 2.*

The size and quantity of pores in solid materials are found by measuring the quantity of mercury that can be forced into the pores of the material under study at various pressures. Since mercury does not usually wet the materials, the mercury will not penetrate the openings among the cluster of particles unless force is applied. Thus, the mercury will penetrate into pores in strict relationship with pressure.

Pore size not only defines the size distribution of the pores of a refractory material, but also defines the size of the bonds formed in the porous matrix and between the porous matrix and dense coarse particles. The size of each bonding area has an important effect on the critical tradeoff in refractories properties. A large number of smaller bond areas can blunt crack propagation and increase crack propagation resistance, thereby improving thermal-shock resistance. However, a smaller number of bonds with a larger cross-sectional area are slower to dissolve and can enhance resistance to slag corrosion.

Fig. 3.8 shows typical pore size distribution results for several refractories. Note the small pore sizes and differences between these products.

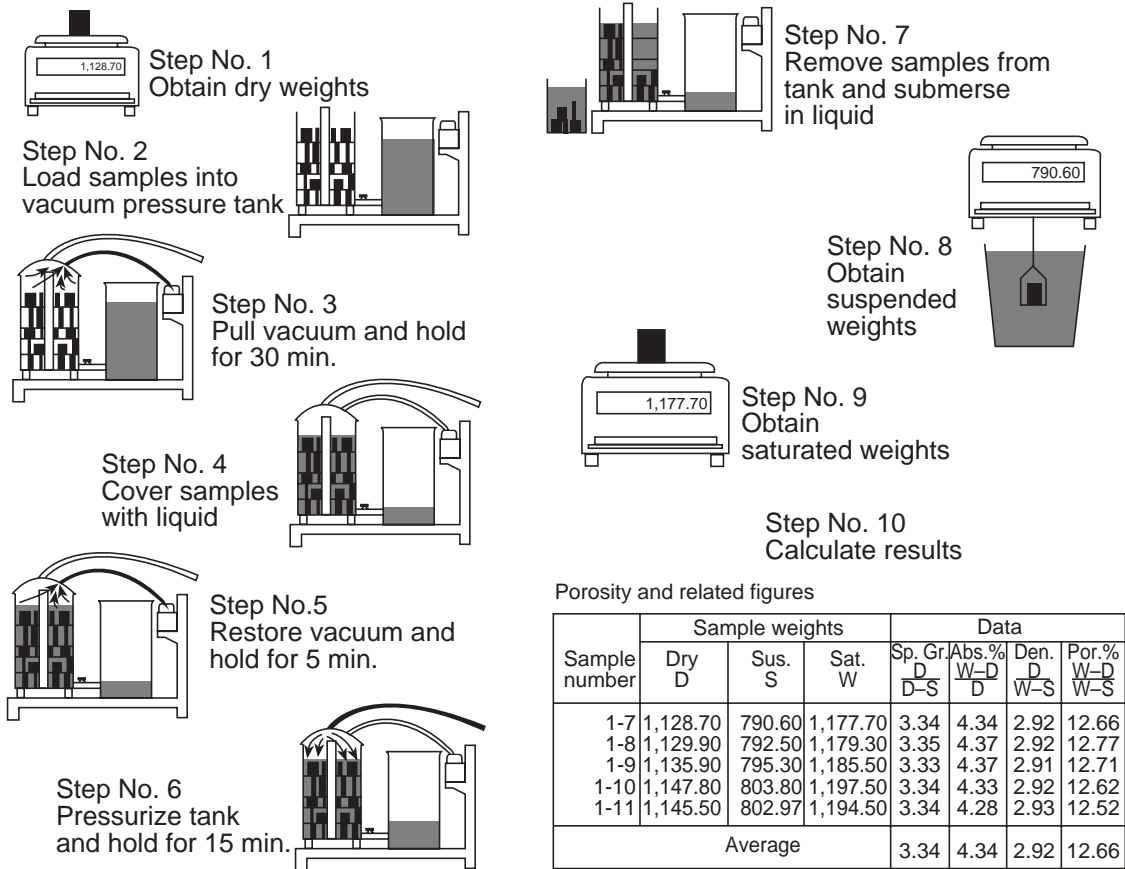


Fig. 3.7 Vacuum pressure technique for measuring porosity in ten steps. From Ref. 2.

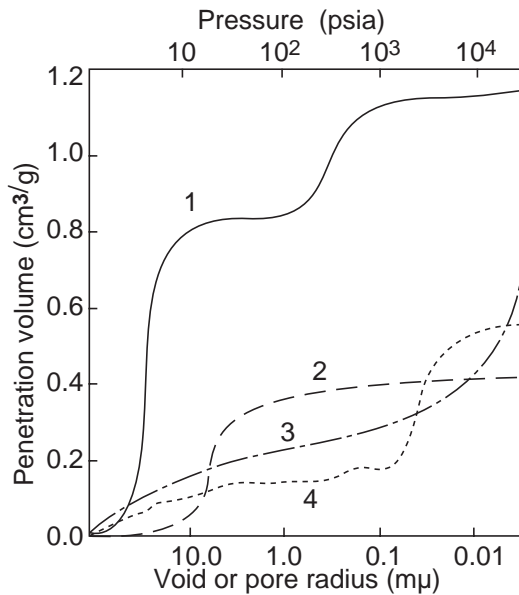


Fig. 3.8 Typical results of pore size distribution in shaped bricks. From Ref. 2.

### 3.3.3 Refractoriness

The use of the classic PCE, pyrometric cone equivalent test, has little usefulness for today's refractories. (This test measures a relative softening point.) The relative refractoriness of modern refractories is more meaningfully measured using tests for deformation under load and /or creep. Table 3.24 shows comparable results in a short time load test.

**Table 3.24 Typical Results of Load Test as Indicated by 24 lb/in<sup>2</sup> Load Testing**

Type of brick	Results of load testing
Fireclay	
Superduty	1.0–3.0% subsidence after heating at 2640°F
High-duty	Withstands load to <2640°F
Low-duty	Withstands load to <2640°F
High-alumina	
60% class	0.1–0.5% subsidence after heating at 2640°F
70% class	0.4–1.0% subsidence after heating at 2640°F
85% class	0.2–0.8% subsidence after heating at 2640°F
90% class	0.0–0.4% subsidence after heating at 3200°F
Corundum class	0.1–1.0% subsidence after heating at 2900°F
Silica (superduty)	Withstands load to 3060°F
Basic	
Magnesite, fired	Withstands load to >3200°F
Manesite-chrome, fired	Withstands load to 2700°F
Magnesite-chrome, unburned	Withstands load to 2950°F
Chrome, fired	Withstands load to 2800°F
Chrome-magnesite, fired	Withstands load to 3020°F
Chrome-magnesite, unburned	Withstands load to 3020°F
Silicon carbide	Withstands load to 2800°F
Zircon	0.1–0.8% subsidence after heating at 2900°F

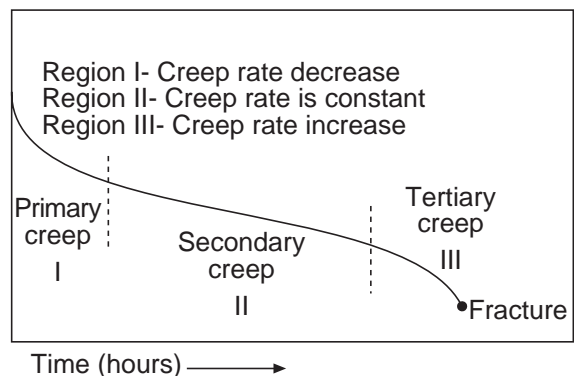
From Ref. 2.

Like most structural materials, refractories experience creep behavior, Fig. 3.9, when exposed to high temperatures ( $0.5 \times$  melting temperature). Most refractories show two characteristic stages of creep. In the first stage, called primary creep, the rate of subsidence declines gradually with time. In the secondary stage, called steady state, the rate of subsidence is constant. At very high temperatures, steady state creep is sometimes followed by tertiary creep region where the rate of subsidence accelerates and leads to catastrophic failure or creep rupture. Primary creep is generally short in duration, while secondary creep can occur over a long term.

Therefore, secondary creep usually provides a more meaningful comparison of refractories. Secondary creep is the parameter determined by the method described above.

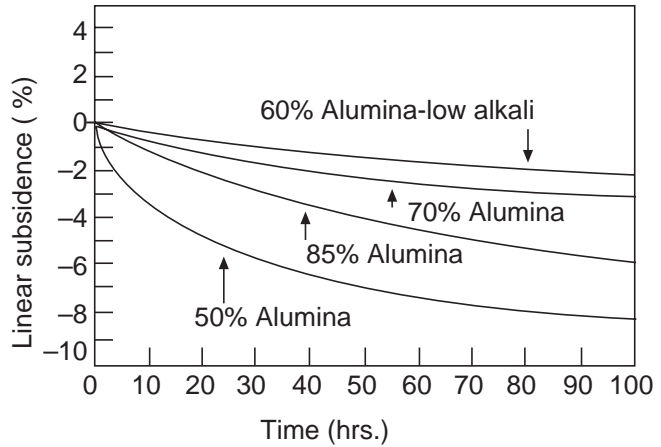
Fig. 3.10 shows creep test results on several high alumina brick. Note that the low-alkali (low impurity) 60%  $\text{Al}_2\text{O}_3$  brick has superior creep resistance to high alumina brick with more alkali.

Such load and creep results are useful in many refractory applications. For example in a blast furnace stove checker setting where loads and temperatures are known, Fig. 3.11, such information can be readily used for design purposes.

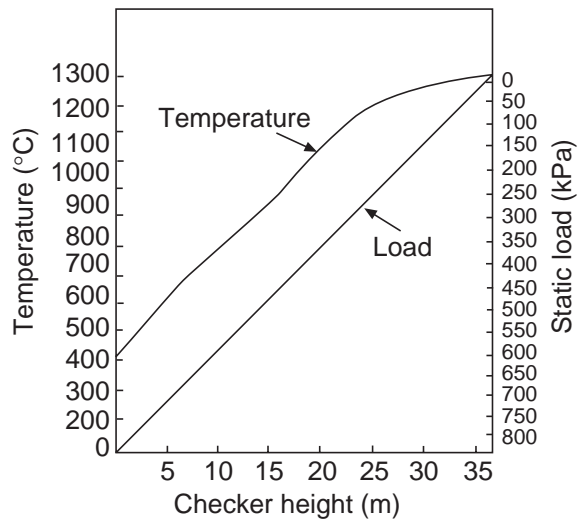


**Fig. 3.9** Conventional creep curve. From Ref. 2.

**Fig. 3.10** Creep measurement of various high-alumina refractories under 25 psi load at 1425°C (2600°F) for 0-100hrs. Note the excellent creep resistance of 60% alumina low alkali brick. *From Ref. 3.*



**Fig. 3.11** Temperature and load distribution in checker setting for 1315°C (2400°F) top temperature.

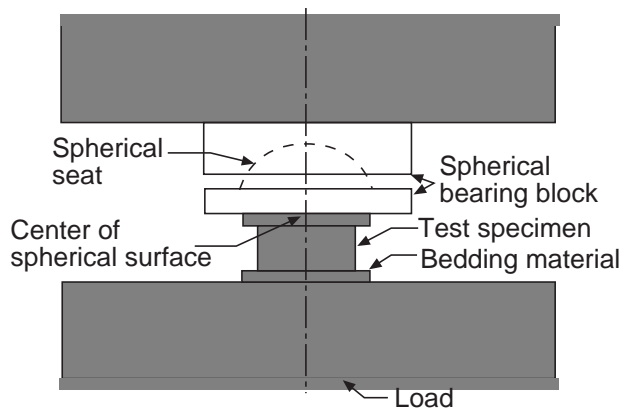


### 3.3.4 Strength

The cold strength(s) of refractories are commonly measured in either compression, Fig. 3.12 or transversely in a modulus of rupture test, Fig. 3.13.

These cold strength values give some measure of the consistency of the refractory product and its ability to function during shipment and installation.

Hot strength values are also determined by similar procedures with the refractory specimen contained in a furnace which may also provide for a protective atmosphere surrounding the specimen. Fig. 3.14 shows the simplest hot modulus of rupture apparatus.



$$C.C.S. (psi) = \frac{\text{load}(lbs)}{\text{area}(in^2)^*}$$

\* Area is cross section area (average) of sample

**Fig. 3.12** Cold crushing strength test apparatus. *From Ref. 2.*



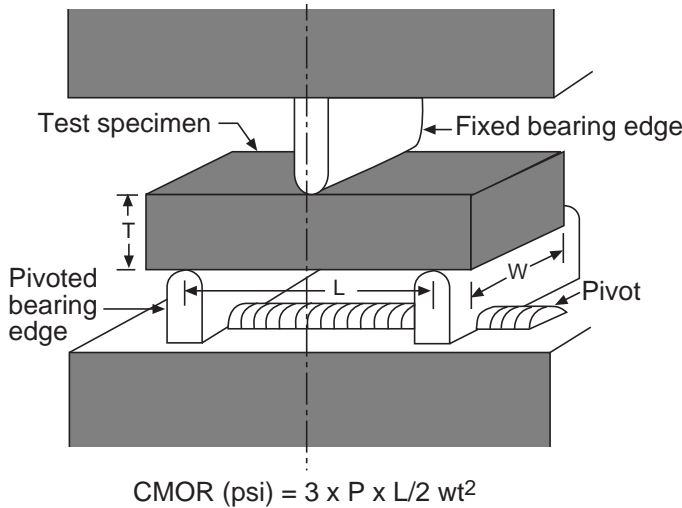


Fig. 3.13 Cold modulus of rupture test apparatus. From Ref. 2.

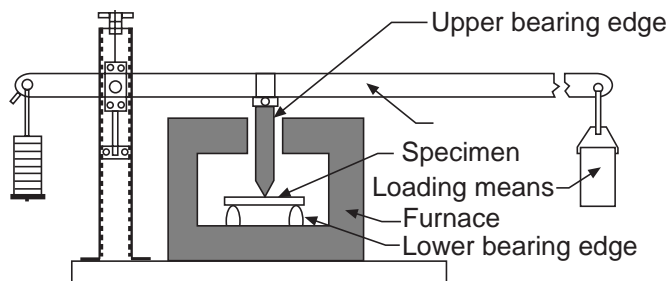


Fig. 3.14 Cross section of a typical hot modulus of rupture apparatus. From Ref. 2.

Table 3.25 Physical Properties of Refractory Brick

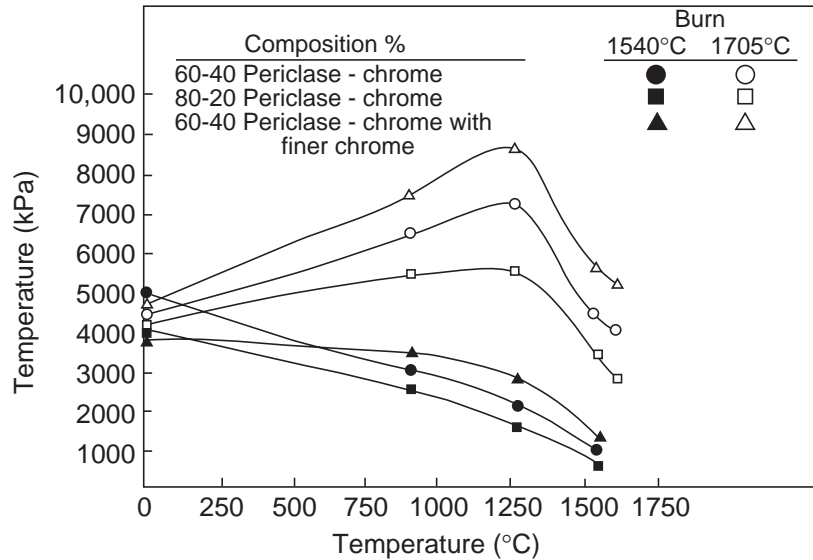
Type of brick	Density (lb/ft <sup>3</sup> )	Apparent porosity (%)	Cold crushing strength (lb/in <sup>2</sup> )	Modulus of rupture (lb/in <sup>2</sup> )
Fireclay				
Superduty	144-148	11.0-14.0	1800-3000	700-1000
High-duty	132-136	15.0-19.0	4000-6000	1500-2200
Low-duty	130-136	10-25	2000-6000	1800-2500
High-alumina				
60% class	156-160	12-16	7000-10,000	2300-3300
70% class	157-161	15-19	6000-9000	1700-2400
85% class	176-181	18-22	8000-13,000	1600-2400
90% class	181-185	14-18	9000-14,000	2500-3000
Corundum class	185-190	18-22	7000-10,000	2500-3500
Silica (superduty)	111-115	20-24	4000-6000	600-1000
Basic				
Magnesite, fired	177-181	15.5-19.0	5000-8000	2600-3400
Magnesite-chrome, fired	175-179	17.0-22.0	4000-7000	600-800
Magnesite-chrome, unburned	185-191	—	3000-5000	800-1500
Chrome, fired	195-200	15.0-19.00	5000-8000	2500-3400
Chrome-magnesite, fired	189-194	19.0-22.0	3500-4500	1900-2300
Chrome-magnesite, unburned	200-205	—	4000-6000	800-1500
Magnesite-carbon	170-192	9.0-13.0	—	1000-2500
Dolomite	165-192	5.0-20.0	1500-3500	500-2500
Fused cast magnesite-chrome	205-245	1.0-15.0	900-1400	6000-8000
Silicon carbide	160-166	13.0-17.0	9000-12,000	3000-5000
Zircon	225-232	19.5-23.5	7000-11,000	2300-3300

From Ref. 3.

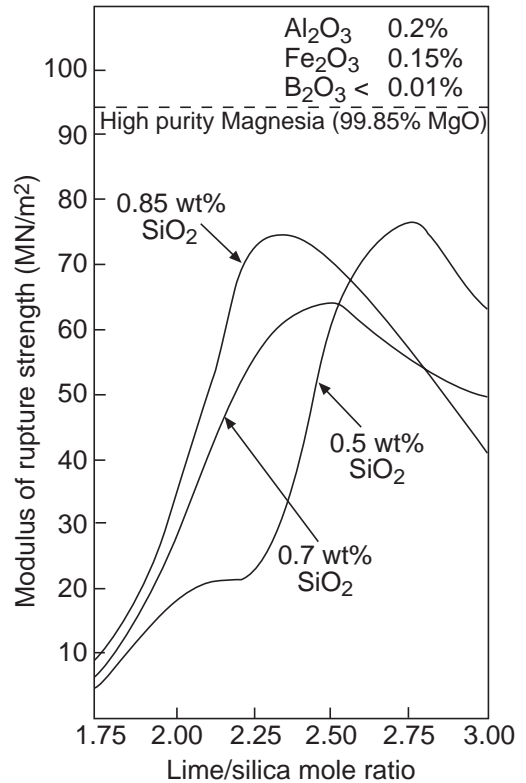
Table 3.25 shows some typical cold properties for several types of refractories and the range of properties between and within these groups are obvious. As previously stated, these cold properties are most useful in rating the consistency of quality of particular refractory products.

The hot strengths of refractories will vary significantly with temperature and with other parameters such as furnace atmosphere. Fig. 3.15 and 3.16 illustrate the complex nature of refractory hot strength for two types of refractories. Fig. 3.15 shows the strength of periclase-chrome refractories as it varies with temperature and is affected by both composition and initial firing temperature during manufacture. Fig. 3.16 shows the strength at a single test temperature as it is influenced by small changes in the impurity ( $\text{SiO}_2$ ) level and the ratio of  $\text{CaO}$  to  $\text{SiO}_2$  in the refractory.

**Fig. 3.15** Strength-temperature relationship for refractories of the indicated compositions.



**Fig. 3.16** Effects of lime/silica ratio on the hot modulus of rupture at 1500°C (2732°F) of burned magnesia bricks containing a different silica level. From Ref. 2.



### 3.3.5 Stress-Strain Behavior

When a refractory is subjected to a mechanical load, it will compress. This behavior may be quantified by the following equation:

$$\epsilon = \frac{\sigma}{E} \tag{3.3.1}$$

where:

- $\epsilon$  = strain (dimensionless),
- $\sigma$  = stress psi (MPa),
- $E$  = Modulus of elasticity, psi (MPa).

Strain is equal to the amount of compression divided by the original length.

$$\epsilon = \frac{\Delta L}{L} \tag{3.3.2}$$

Stress is the force applied per unit area.

$$\sigma = \frac{F}{A} \tag{3.3.3}$$

The modulus of elasticity, or Young's Modulus, of a refractory is constant for a given material and temperature.

The stress-strain behavior of a refractory material is determined by a method which is similar to that used to measure hot crushing strength. A cylindrical sample is heated uniformly to the test temperature and compressed using a mechanical testing machine. While loading the sample, the change in its height is monitored by an electrical transducer which is connected by sapphire sensing rods with the top and bottom of the sample. The data are used to create a stress versus strain curve.

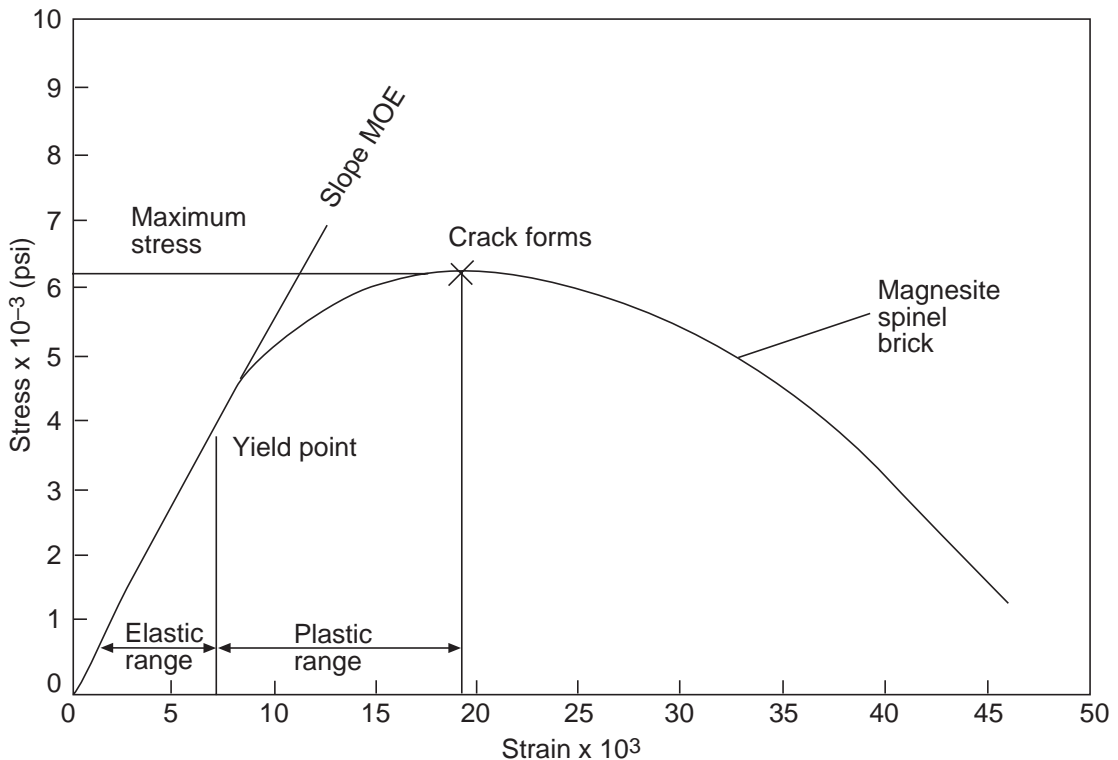


Fig. 3.17 Example of stress-strain curve for magnesite-spinel brick. From Ref. 3.

**Table 3.26 Static Modulus of Elasticity (approximate values)**

Type of brick	Modulus of Elasticity at 2000°F (psi)
Silica	$9.0 \times 10^5$
50% alumina	$6.9 \times 10^5$
60% alumina	$17.0 \times 10^5$
Magnesite-alumina-spinel	$14.0 \times 10^5$
Magnesite-chrome	$12.0 \times 10^5$
Magnesite	$9.3 \times 10^5$
Magnesite-tar impregnated	$21.0 \times 10^5$
Magnesite-tar bonded	$14.0 \times 10^5$
Magnesite-carbon (20%)	$4.4 \times 10^5$
Magnesite-carbon (15%)	$4.0 \times 10^5$

From Ref. 3.

An understanding of the stress-strain behavior of refractories at elevated temperatures is important in nearly all applications. The shell or superstructure of a vessel usually acts to restrain the thermal expansion of the lining. Proper lining design may require gaps in the lining (thermal expansion allowance) during installation to prevent catastrophic stress buildup in the lining during heating. However, the expansion allowance must also be designed to prevent instability of the lining. The engineer, too, must be concerned with the stresses which the expanding refractories induce in the vessel shell or superstructure. Section 3.5 on the selection of refractories will further describe analysis techniques for refractory behavior under stress.

### 3.3.6 Specific Heat

The specific heat of a refractory material indicates the amount of heat necessary to change its temperature by a given amount. The specific heat is the amount of heat in British Thermal Units (BTU's) which must be absorbed by one pound of material to raise its temperature by one degree Fahrenheit. Table 3.27 gives the specific heats of several types of refractory brick and refractory minerals.

**Table 3.27 Specific Heats of Refractory Brick and Minerals**

Mean Specific Heats between 32°F, and T°F, in BTU per pound per °F										
T°F	Fireclay Brick	Silica Brick	Magnesite Brick	Chrome Brick	Forsterite Brick	T°F	Mullite 3Al <sub>2</sub> O <sub>3</sub> ·2SiO <sub>2</sub>	Cristobalite SiO <sub>2</sub>	Periclase MgO	Corundum Al <sub>2</sub> O <sub>3</sub>
32	0.193	0.169	0.208	0.170	0.180	32	0.184	0.165	0.208	0.171
200	0.199	0.188	0.219	0.176	0.200	200	0.192	0.183	0.227	0.196
400	0.206	0.211	0.232	0.182	0.216	400	0.214	0.204	0.240	0.214
600	0.212	0.229	0.242	0.188	0.230	600	0.223	0.239	0.251	0.226
800	0.220	0.238	0.251	0.194	0.240	800	0.229	0.251	0.257	0.235
1000	0.227	0.246	0.258	0.199	0.246	1000	0.233	0.258	0.262	0.242
1200	0.234	0.252	0.263	0.204	0.250	1200	0.237	0.264	0.267	0.248
1400	0.241	0.256	0.268	0.208	0.254	1400	0.240	0.268	0.270	0.252
1600	0.248	0.260	0.273	0.212	0.258	1600	0.242	0.271	0.274	0.257
1800	0.253	0.264	0.278	0.216	0.262	1800	0.245	0.273	0.277	0.260
2000	0.258	0.268	0.283	0.220	0.266	2000	0.247	0.275	0.280	0.264
2200	0.262	0.272	0.288	0.222	0.270	2200	0.249	0.277	0.282	0.267
2400	0.266	0.276	0.293	0.224	0.274	2400	0.251	0.278	0.285	0.270
2600	0.269	0.279	0.297	0.226	0.278	2600	0.253	0.279	0.288	0.273
						2800	0.255	0.280	0.290	0.276
						3000	0.256	0.281	0.292	0.279
						3200	0.258	—	0.294	0.282

From Ref. 3.

Fig. 3.17 illustrates a typical stress-strain curve. The initial portion of the curve is usually linear and is called the elastic range. The slope of the curve over this range gives the modulus of elasticity. The point at which the stress-strain curve becomes non-linear is called the yield point. Straining the material beyond this point results in permanent deformation; this portion of the curve is known as the plastic range. Further straining of the material brings failure. Some materials do not show plastic behavior at certain temperatures, but instead fail after elastic straining. Modulus of elasticity values of a number of refractories are shown in Table 3.26.

The specific heat values for refractory materials are important in many applications because the amount of heat stored in the lining during heating is often significant. In furnaces which are cycled, large amounts of heat are alternately stored during heating stages and lost to the surroundings during cooling stages. Applications for which high specific heat is desirable include blast furnace stoves. Stoves are specifically designed to absorb and store heat from hot waste gases. The stored heat is subsequently used to preheat combustion air.

### 3.3.7 Emissivity

Emissivity is the relative power of a surface to emit heat by radiation. It is expressed as a fraction of the emissivity of an ideal black body. Such black body radiation is the maximum possible, but it is never achieved by actual materials. A good radiator is an equally good absorber of heat. A good reflector, obviously, is a poor absorber, and consequently a poor radiator. A perfect reflector, which also does not exist, would have an emissivity of zero. Materials do not radiate equally well at all wavelengths. The ability to radiate at a particular wavelength is referred to as the monochromatic emissivity. Total emissivity refers to heat radiation over the entire spectrum of wavelengths. The total emissivity of most refractories decreases somewhat with an increase in temperature.

Emissivities dictate the amount of heat which is radiated across a gap in a refractory structure. The equation used to calculate this quantity is

$$Q_r = \sigma \left( \frac{T_1^4 - T_2^4}{\frac{1}{\epsilon_1} + \frac{1}{\epsilon_2 - 1}} \right) \quad (3.3.4)$$

where:

- $Q_r$  = heat radiated across gap,  $Wm^{-2}$  (BTU  $hr^{-1}$   $ft^{-2}$ ),
- $\sigma$  = Stefan-Boltzmann constant,  $W/m^{-2} K^{-4}$  (BTU  $hr^{-1}$   $ft^{-2}$   $^{\circ}R^{-4}$ ),
- $T_1$  = temperature of hotter surface of gap, K ( $^{\circ}R$ ),
- $T_2$  = temperature of cooler surface of gap, K ( $^{\circ}R$ ),
- $\epsilon_1$  = emissivity of hotter surface of gap, dimensionless,
- $\epsilon_2$  = emissivity of cooler surface of gap, dimensionless.

In the above equation, the temperatures must be expressed using an absolute temperature scale. The temperature in Kelvins is  $K = ^{\circ}C + 273$ ; the temperature in degrees Rankin is  $^{\circ}R = ^{\circ}F + 460$ . The Stefan-Boltzmann constant is  $5.670 \times 10^{-9} Wm^{-2} K^{-4}$  ( $1.714 \times 10^{-9}$  BTU  $hr^{-1}$   $ft^{-2}$   $R^{-4}$ )

The emissivity of the outermost component of a vessel determines, to a large extent, the amount of heat radiated to the surroundings. The loss to the environment by unobstructed radiation is given by:

$$Q_r = \epsilon \sigma (T_1^4 - T_2^4) \quad (3.3.5)$$

where:

- $Q_r$  = heat radiated to surroundings,  $Wm^{-2}$  (BTU  $hr^{-1}$   $ft^{-2}$ ),
- $\sigma$  = Stefan-Boltzmann constant,  $W/m^{-2} K^{-4}$  (BTU  $hr^{-1}$   $ft^{-2}$   $^{\circ}R^{-4}$ ),
- $\epsilon$  = emissivity of outer surface, dimensionless,
- $T_1$  = temperature of outer surface, K ( $^{\circ}R$ ),
- $T_2$  = temperature of surroundings, K ( $^{\circ}R$ ).

In most applications, the outer surface is a metallic shell such as carbon steel plate. the emissivity of the shell, in this case, is affected by the degree of oxidation. The emissivity tends to increase as the amount of oxidation increases.

Emissivity values for a number of refractories and materials commonly used for shells are listed in Table 3.28

**Table 3.28 Representative Values of Total Emissivity**

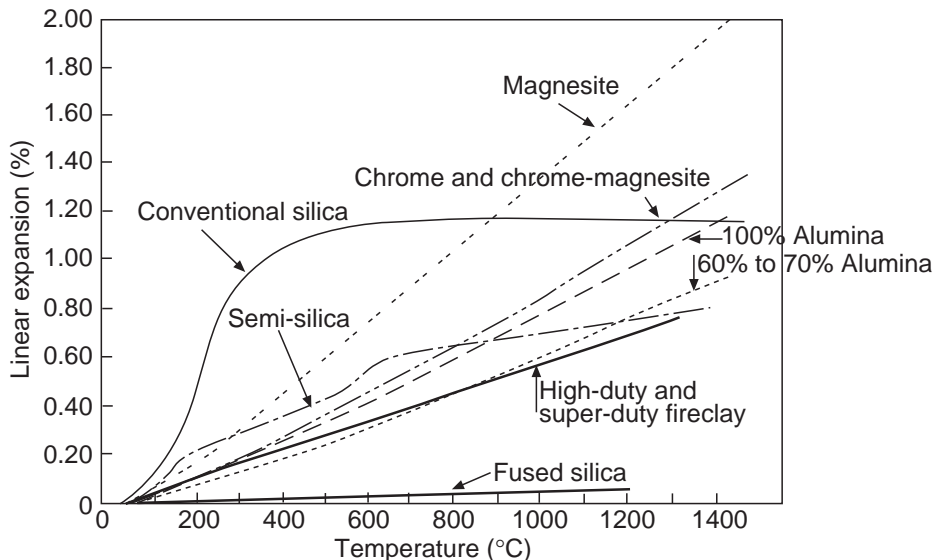
Material	Temperature °F						
	200	400	800	1600	2000	2400	2800
Fireclay Brick	.90	(.90)	(.90)	.81	.76	.72	.68
Silica Brick	(.90)	—	—	.82-.65	.78-.60	.74-.57	.67-.52
Chrome-Magnesite Brick	—	—	—	.87	.82	.75	.67
Chrome Brick	(.90)	—	—	.97	.975	—	—
High-Alumina Brick	.90	.85	.79	(.50)	(.44)	—	—
Mullite Brick	—	—	—	.53	.53	.62	.63
Silicon Carbide Brick	—	—	—	.92	.89	.87	.86
Carbon Steel	.80	—	—	—	—	—	—
Aluminum	.20	—	—	—	—	—	—

(Figures in parentheses were obtained by extrapolation of test data.)

From Ref. 3.

### 3.3.8 Thermal Expansion

All refractories expand on heating in a manner related to their compositions. Fig. 3.18 shows classic examples of the expansion of divergent refractory types. It is obvious that the shape of the expansion curve with temperature and the maximum magnitude of the expansions differ appreciably. Compressible materials or voids are used for relieving such thermal expansion in any refractory construction because growth of several inches can obviously be experienced. Refractories with linear or near linear thermal expansion generally require considerably less care than those with non-linear expansion characteristics. A classic example of a refractory that requires care during heatup is silica brick, which after firing consists of a carefully controlled balance of various mineral forms of the compound SiO<sub>2</sub>. Fig. 3.19 shows the thermal expansion of the various silica mineral forms which make slow heatup through various critical ranges necessary. As a result of the complex mineral makeup of silica brick, large constructions using these brick (such as coke ovens) are heated and cooled at very slow rates and may require several weeks to reach operating temperatures. Once the critical temperature ranges are passed, however, silica brick exhibit low and uniform thermal expansion and may be thermally cycled without damage between 1000–1538°C (1800–2800°F)



**Fig. 3.18** Typical curves of linear expansion of various types of refractories.

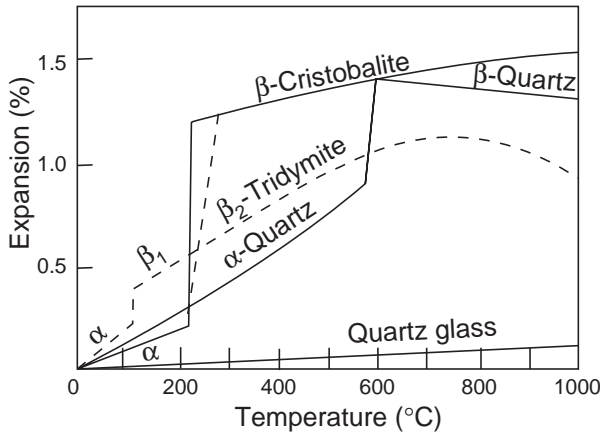


Fig. 3.19 Thermal expansion of silica minerals.

In general, the thermal expansion behaviors of unfired refractories are more complex than those of their fired counterparts. During initial heating, dramatic expansions or contractions may occur in an unfired material as a result of changes in bonding structure, changes in mineralogy, and sintering effects.

The thermal expansion characteristics of a number of cement-bonded refractories during initial heat-up are shown in Fig. 3.20. These materials show shrinkage over the temperature range 205–315°C (400–600°F) which is associated with thermal decomposition of the cement. The amount of shrinkage is determined by the quality and

amount of cement. At temperatures above 980 to 1090°C (1800 to 2000°F), additional shrinkage occurs as a result of sintering. The underlying thermal expansion is determined by the characteristics of the aggregate. The shrinkages which take place during initial heat-up to 1430°C (2600°F) are permanent in nature and commonly are on the order of 0.2 to 1.5%.

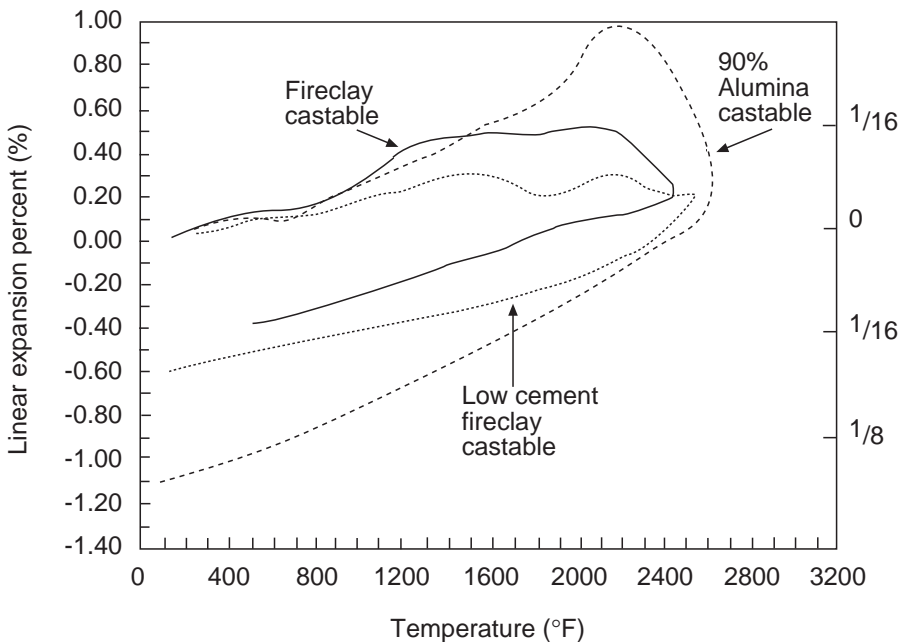
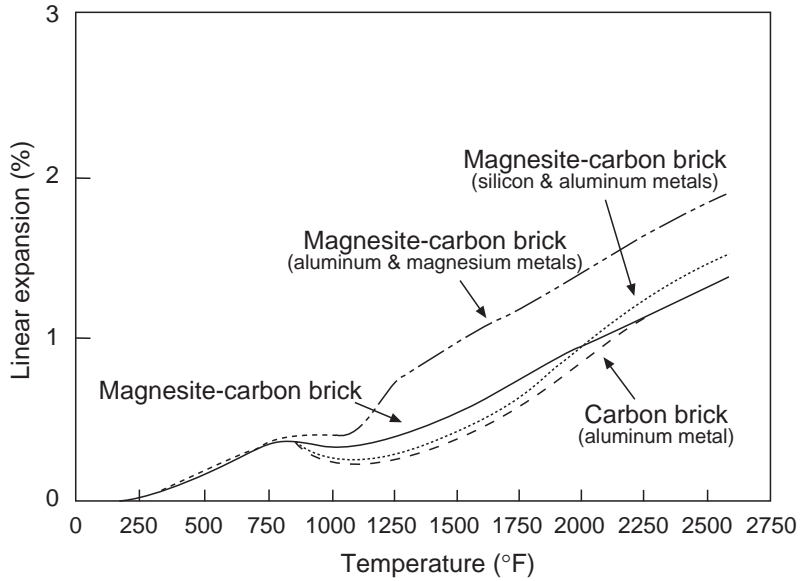


Fig. 3.20 Thermal expansion of various refractory castables. From Ref. 3.

Thermal expansion curves for a number of magnesite-carbon brick are shown in Fig. 3.21. Through the temperature range 370–540°C (700–1000°F), the formation of a glassy carbon bond tends to densify the structure and shrinkage results. In materials which contain metals, expansive reactions take place at higher temperatures. Brick which contain magnesium show a dramatic thermal expansion over the range 540–705°C (1000–1300°F). Materials containing aluminum show gradual acceleration of expansion above about 760°C (1400°F). Thermal expansion at high temperatures increases significantly with increases in metals content. After heating to 1430°C (2600°F), magnesite-carbon brick show permanent expansion of 0.1 to 1.0%.

**Fig. 3.21** Thermal expansion of magnesite-carbon brick. From Ref. 3.



### 3.3.9 Thermal Conductivity and Heat Transfer

As insulators, refractory materials have always been used to conserve heat, and their resistance to heat flow is a prime selection factor in many applications. Fig. 3.22 shows thermal conductivity curves for several refractory types ranging from dense refractories to insulating brick. Some refractories (for example, carbon or silicon carbide) have appreciably higher conductivities (up to 43.26  $Wm^{-1}K^{-1}$  or 300  $BTU\ hr^{-1}ft^{-2}^{\circ}F\ in^{-1}$ ) whereas others are available with conductivities lower than 0.14  $Wm^{-1}K^{-1}$  or 1  $BTU\ hr^{-1}ft^{-2}^{\circ}F\ in^{-1}$  (for example, block insulation or refractory fiber forms).

Using measured conductivity values, heat transfer losses through single or multiple component refractory walls can be calculated using the general formula:

$$\frac{Q}{A} = \frac{T_1 - T_2}{\frac{L_1}{K_1} + \frac{L_2}{K_2} + \dots + \frac{L_n}{K_n}} \quad (3.3.6)$$

where:

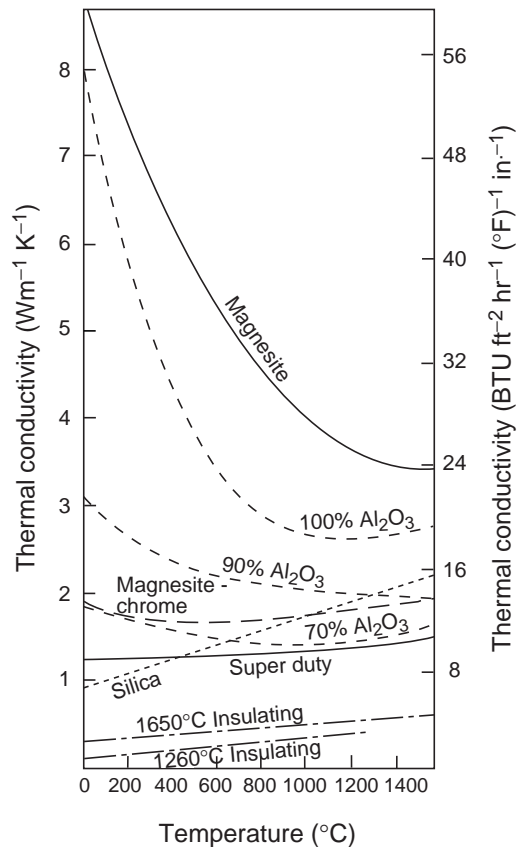
$Q/A$  = heat loss expressed as  $Wm^2$  ( $BTU\ hr^{-1}ft^{-2}$ ),

$T_1$  = temperature of the hotter surface,  $^{\circ}C$  ( $^{\circ}F$ ),

$T_2$  = temperature of the cooler surface,  $^{\circ}C$  ( $^{\circ}F$ ),

$L_1, L_2 \dots L_n$  = thickness of each material, (in.),

$K_1, K_2 \dots K_n$  = thermal conductivity of each material,  $Wm^{-1}K^{-1}$  ( $BTU\ in.\ ft^{-2}hr^{-1}^{\circ}F^{-1}$ ).



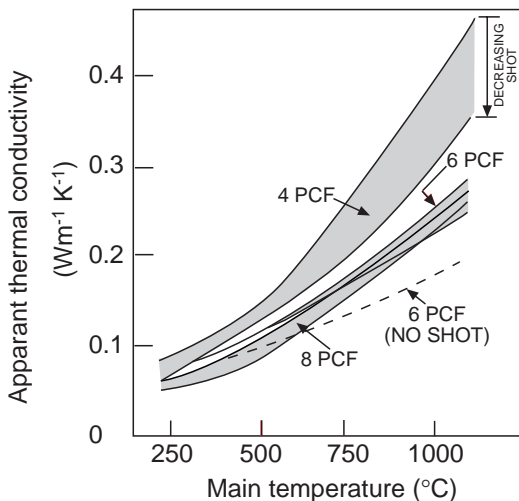
**Fig. 3.22** Typical thermal conductivity curves for various refractory brick.



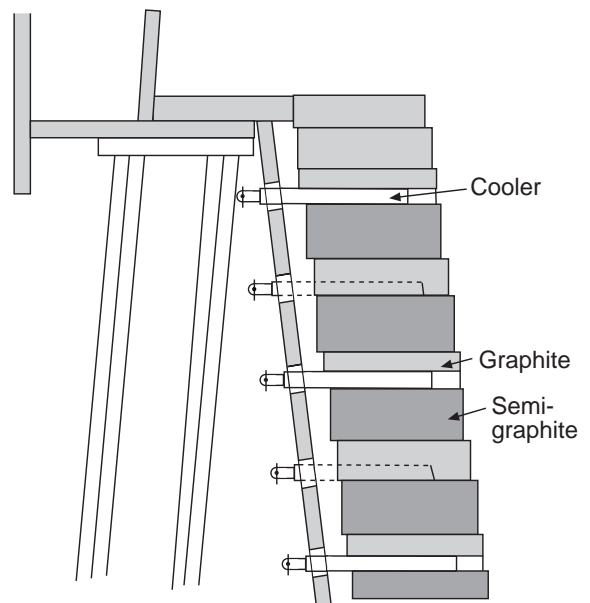
Such calculations are now rapidly made using computer simulations where calculated heat transfer rates can be balanced with loss from the outer refractory surface by radiation and natural or forced convection. Moreover, where once it was a slow mathematical process to determine even the steady-state heat times, the advent of computers has made the rapid determination of the heat transfer data for even transient conditions routine. Although it might seem that every construction should be designed for minimum heat losses, this is not always the case, and care must be taken in some situations including the following:

- (1) The hot face refractories in a particular application must be able to withstand the higher temperatures that will result when layers of highly insulating backup materials are added.
- (2) Other refractory properties must be suitable for the environment. For example, most insulating materials will not stand direct exposure to metal or slag, and backup materials may be subject to attack by vaporized process components (alkali, sulfur compounds, acids) or their condensates. Gas channeling through permeable materials must also be considered to prevent hot spots on shells.
- (3) Insulation increases the depth of penetration and chemical attack on the hot-face layer.

A wide variety of very insulating fiber based refractories are available in bulk, blanket, board, or shaped forms. In such products, thermal conductivity is highly dependent on product density as shown in Fig. 3.23.



**Fig. 3.23** Thermal conductivity as a function of temperature for various fiber materials.



**Fig. 3.24** Use of ultra-conductivity materials in a typical bosh construction.

In certain applications, very high conductivity refractories are used to cool the refractory lining and stabilize it against further refractory wear. Fig. 3.24 for example shows a blast furnace bosh using graphite and semi-graphite materials with conductivities of 70–80 and 30–35 Wm<sup>-1</sup>K<sup>-1</sup>, respectively, at 1000°C. (Note these values in comparison to the more conventional refractories shown in Fig. 3.22). In such designs, heat extracted through the copper coolers enables the refractories to last many times longer than uncooled linings. Similarly, a composite construction with silicon carbide in a blast furnace stack as shown in Fig. 3.25 controls shell temperatures and allows the formation of a stable lining. In this case the cooling plate density is desirable as varying from none to very close or dense.

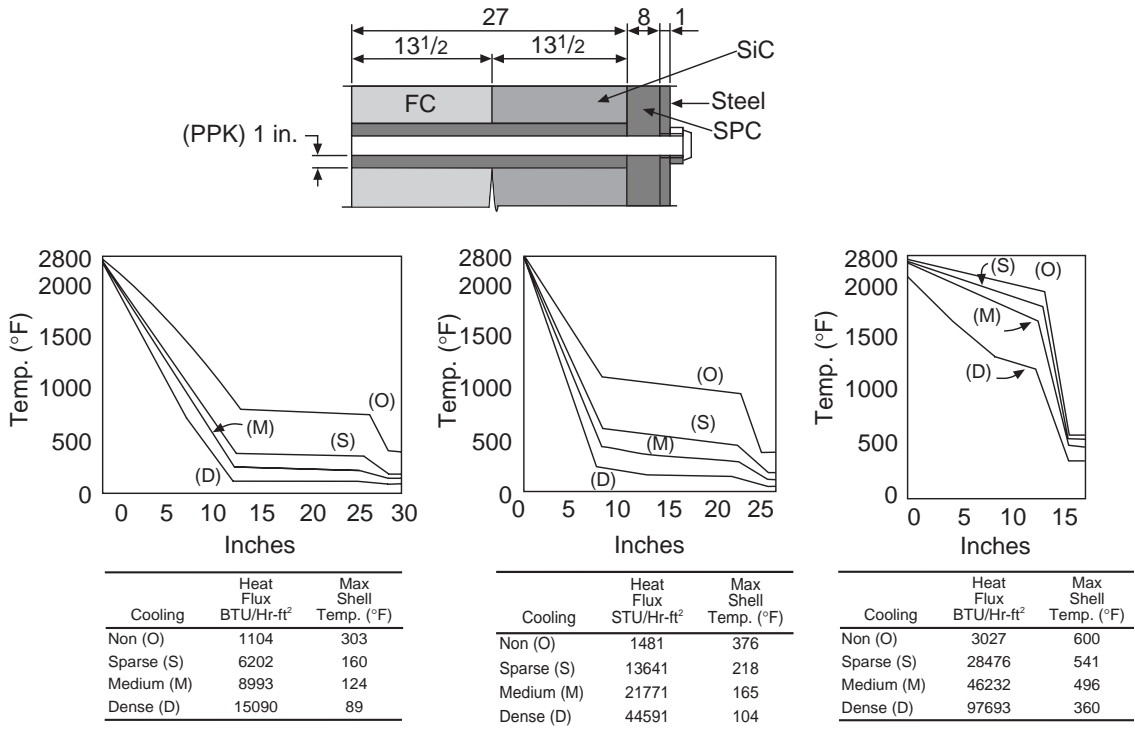


Fig. 3.25 Temperature profile for lining B.

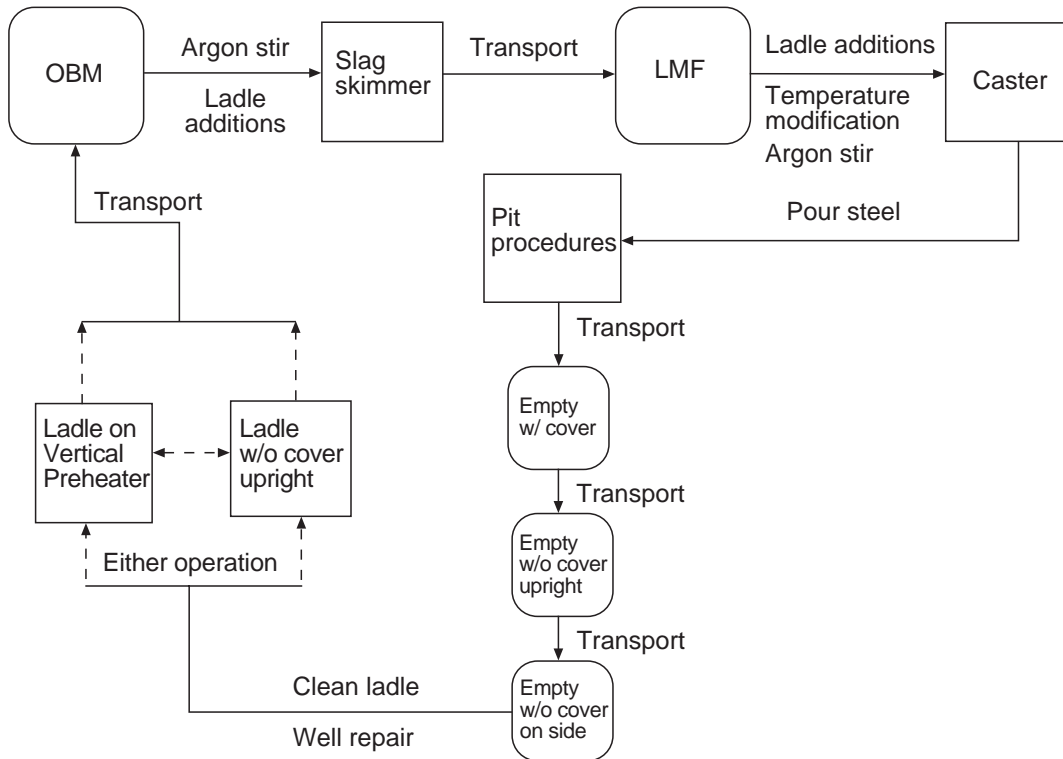


Fig. 3.26 Ladle cycling procedure.

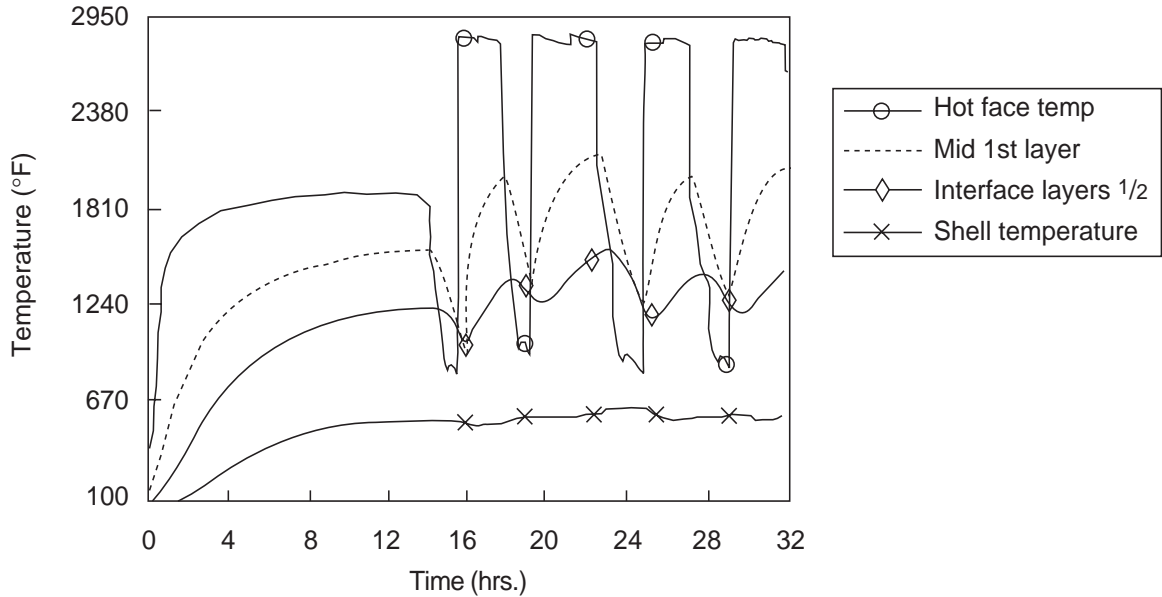


Fig. 3.27 Transient phenomena in ladle cycling.

Many steelplant refractory applications also never reach thermal equilibrium, and dynamic heat transfer calculations must be employed in the analysis of such applications. For example, a typical steel ladle will cycle several times daily as shown in Fig. 3.26. During such cycles, the temperature at the hot face and to a lesser extent the entire lining, will show cyclic behavior, as displayed in Fig. 3.27.

Importantly, remember that while heat flow at steady state is governed by thermal conductivity  $k$  (first Fourier's law), the material property required in the transient case is thermal diffusivity  $\lambda$  (second Fourier's law).

Thermal diffusivity  $\lambda$  is the equivalent of a diffusion coefficient in the Fourier equation for heat flow and is a measure of how fast a heat pulse is transmitted through a solid. Thermal diffusivity is related to both thermal conductivity and heat capacity through the relationship:

$$\lambda = \frac{k}{\rho C_p} \quad (3.3.7)$$

where:

$$\begin{aligned} k &= \text{thermal conductivity,} \\ \rho &= \text{density} \\ C_p &= \text{heat capacity,} \\ \lambda &= \text{m}^2\text{s}^{-1}. \end{aligned}$$

Thermal diffusivity is most commonly determined by the heat-pulse method where a heat pulse is applied to one side of a disc or short cylinder and the time period for the temperature of the opposite face to reach one-half its final value is recorded. The heat pulse is commonly provided by a power laser flash.

Table 3.29 shows some diffusivity values for selected products. The relationship among density, heat capacity, thermal conductivity and thermal diffusivity should be borne in mind, so if one property is unknown, the others can be readily calculated.

**Table 3.29 Thermal Diffusivity of Different Products, in  $10^{-6} \text{ m}^2\text{s}^{-1}$** 

	25°C	500°C	1000°C	1500°C
Alumina > 99.5%	10.7	2.6	1.8	1.3
Alumina, 90%	6.2	1.7	1.2	0.9
Magnesia, 30% porous	~ 12	~ 4	~ 1.5	—
Spinel	~ 6	~ 2	~ 1.2	—
Zirconia (cubic)	0.7	0.6	0.5	0.6
Silicon carbide (dense)	40–50	15–18	11–13	7–9
Graphite ⊥ c	250–1000	50–150	30–75	—
Graphite   c	2.8–5.4	0.4–0.8	0.2–0.5	—

From Ref. 2

### 3.3.10 Thermal Shock

Thermal shock resistance is a complex issue when investigating refractory system design. Thermal shock or spalling is caused by thermal stresses which develop from uneven rates of expansion and contraction within the refractory, caused by rapid temperature changes or high inherent temperature gradients in a refractory. A qualitative prediction of the resistance of materials to fracture by thermal shock can be expressed by the factor:

$$\frac{ks}{\alpha E} \quad (3.3.8)$$

where:

- k = thermal conductivity,
- s = tensile strength,
- $\alpha$  = coefficient of thermal expansion,
- E = modulus of elasticity.

The higher the value of the factor in Eq. 3.3.8, the higher the predicted thermal shock resistance of the material. Some measure of shock resistance can be obtained using the work of fracture measurements at elevated temperatures to predict the energy to propagate a slow moving crack. Other thermal shock measurement techniques usually involve thermal cycle tests as described in Section 3.5.

## 3.4 Reactions at Elevated Temperatures

The foregoing discussion of the high temperature behavior of refractories emphasizes physical factors, but refractory behavior also depends greatly on high temperature reactions occurring not only within the the refractories themselves but between refractories and contaminants encountered in service.

Phase equilibrium diagrams have proved to be invaluable guides to understanding service reactions and the influence of composition on refractory properties. As excellent compilations of diagrams have been published (see references at end of chapter), only a few are reproduced here. However, it should be recognized that these diagrams are not without limitations in their use to predict or explain refractory behavior. For example, the various systems have been explored using simple combinations of pure oxides and represent equilibrium conditions, while refractories are rarely pure and seldom in equilibrium, either as manufactured or in service. Because of this complex chemical nature of refractories, information is often needed on reactions involving so many oxides that the usefulness of phase equilibrium information on systems involving three or four oxides is minimal. The diagrams also give no information on such significant matters as viscosity of the liquids formed or the rates at which reactions proceed.

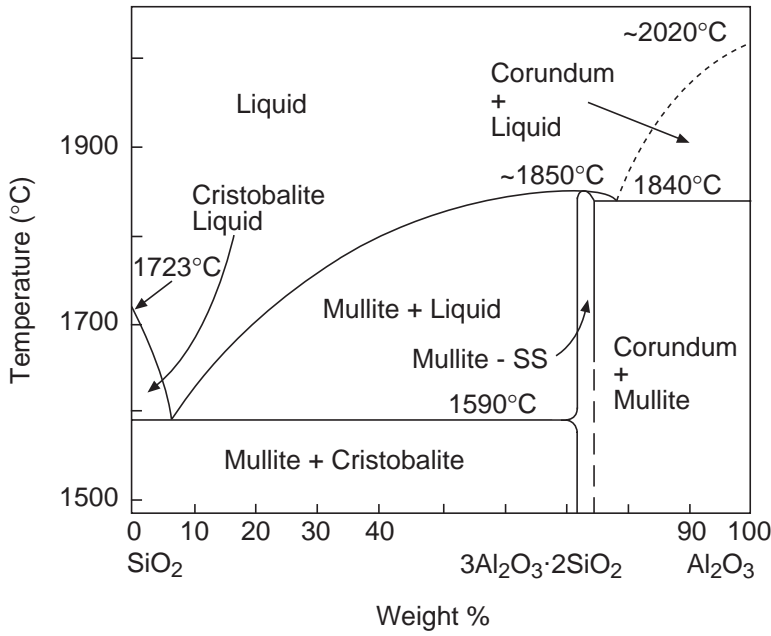


Fig. 3.28 Phase diagram of the  $\text{Al}_2\text{O}_3$ - $\text{SiO}_2$  system.

Fig. 3.28 shows the  $\text{Al}_2\text{O}_3$ - $\text{SiO}_2$  system which applies to silica, fireclay, and high alumina refractories. It will be noted that the lowest temperature at which any liquid is developed in the system is  $1590^{\circ}\text{C}$  ( $2894^{\circ}\text{F}$ ), while those compositions more aluminous than mullite ( $3\text{Al}_2\text{O}_3 \cdot 2\text{SiO}_2$ ) or above 71.8%  $\text{Al}_2\text{O}_3$  develop liquids at quite high temperatures. It is obvious that useful refractories can be made of the pure oxides  $\text{Al}_2\text{O}_3$  or  $\text{SiO}_2$ . The pronounced effect of the impurities present in most commercial refractories in this system can be appreciated by comparing the temperatures at which they deform initially under load,  $1150$ – $1200^{\circ}\text{C}$  ( $2100$ – $2200^{\circ}\text{F}$ ), with the initial liquid temperatures of  $1540$  or  $1840^{\circ}\text{C}$  ( $2874$  or  $3344^{\circ}\text{F}$ ) indicated on the diagram. The oxide impurities largely responsible for lowering the refractoriness of fireclay refractories are  $\text{CaO}$ ,  $\text{MgO}$ ,  $\text{FeO}$ ,  $\text{Na}_2\text{O}$ , and  $\text{K}_2\text{O}$ . As previously described, mining and beneficiation techniques are now widely used to obtain raw materials with minimum impurity levels.

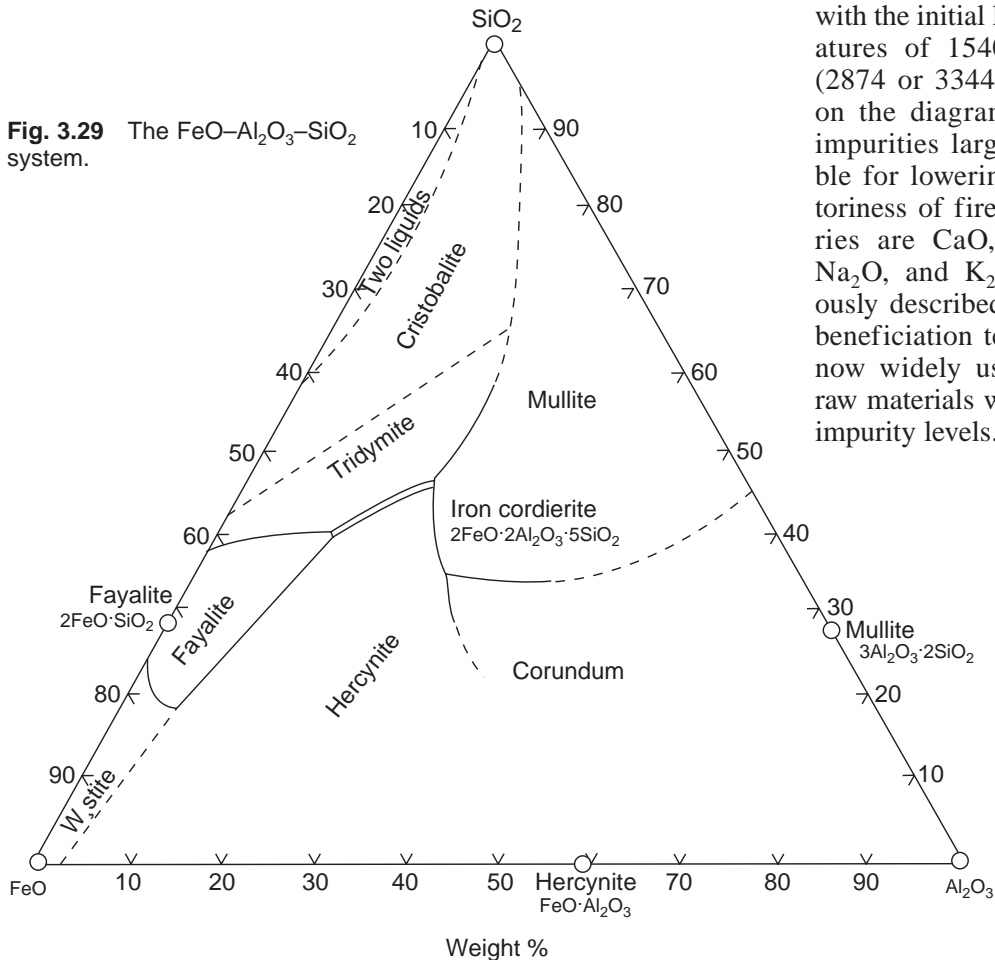


Fig. 3.29 The  $\text{FeO}$ - $\text{Al}_2\text{O}_3$ - $\text{SiO}_2$  system.

Fig. 3.29 shows the FeO–Al<sub>2</sub>O<sub>3</sub>–SiO<sub>2</sub> system. Here it is seen that the formation of some liquid can be expected even below about 1095°C (2000°F) with Al<sub>2</sub>O<sub>3</sub>–SiO<sub>2</sub> refractories and that very damaging amounts will be formed at the higher temperatures common to iron and steel processes. This is particularly true as iron oxide bearing liquids are characteristically very fluid.

Fig. 3.30 is the diagram of the CaO–Al<sub>2</sub>O<sub>3</sub>–SiO<sub>2</sub> system, which is most applicable to reactions of fireclay refractories with blast furnace slags and indicates superior resistance for higher Al<sub>2</sub>O<sub>3</sub> products in such environments. This system has also been useful in predicting behavior of silica brick, which will be discussed later.

The ternary phase equilibrium diagrams for K<sub>2</sub>O or Na<sub>2</sub>O reactions with Al<sub>2</sub>O<sub>3</sub> and SiO<sub>2</sub> are reproduced in Fig. 3.31 and Fig. 3.32. It is evident that the refractoriness of alumina-silica refractories will be seriously affected by very small amounts of Na<sub>2</sub>O, less than 1% being sufficient to lower the temperature of initial liquid formation to less than about 1095°C (2000°F), while approximately 10% is sufficient to completely liquefy the more siliceous alumina-silica compositions at about 1205°C (2200°F). Potassium oxide (K<sub>2</sub>O) has a similar effect in amounts up to 10%.

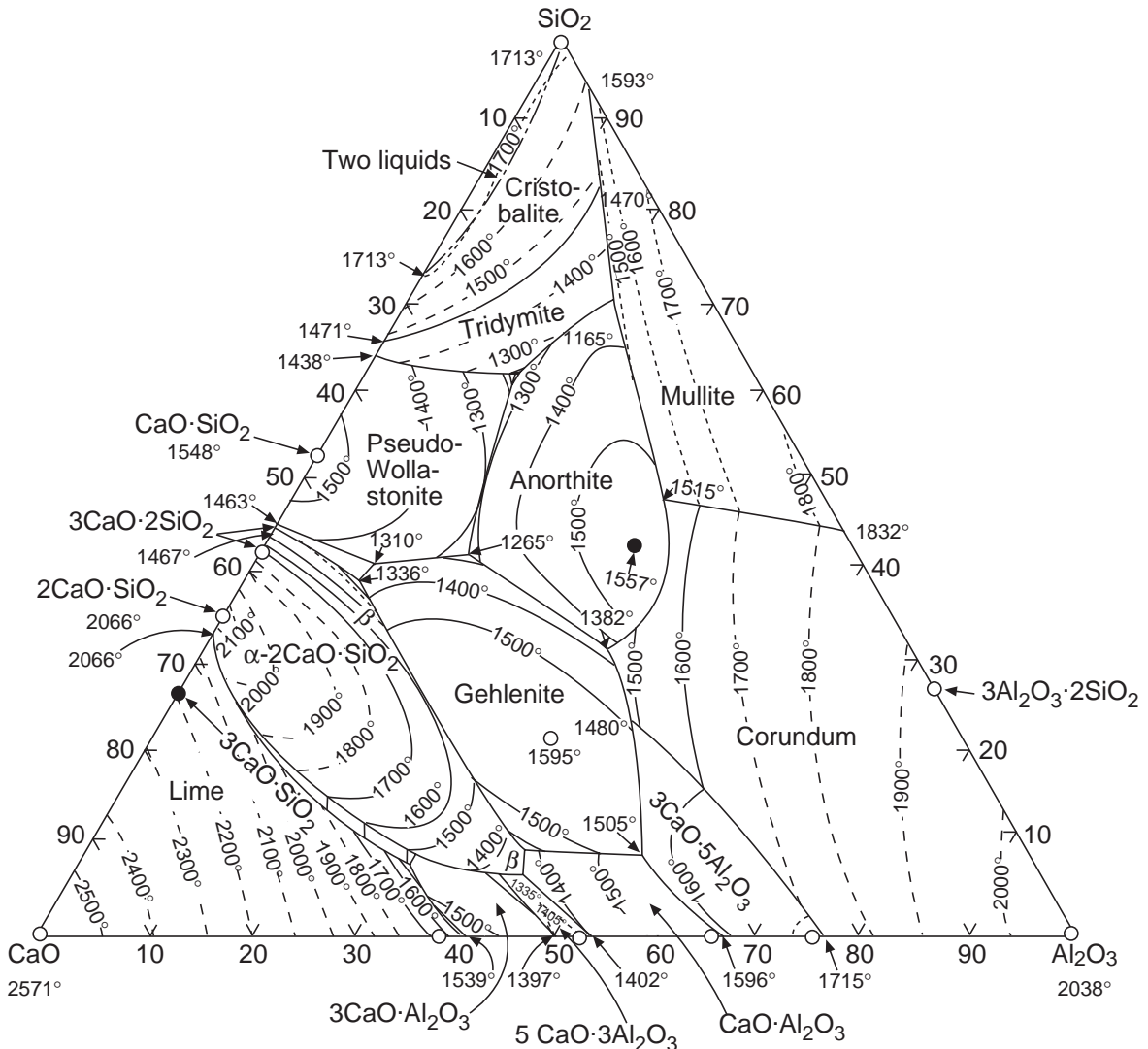


Fig. 3.30 The CaO–Al<sub>2</sub>O<sub>3</sub>–SiO<sub>2</sub> system.

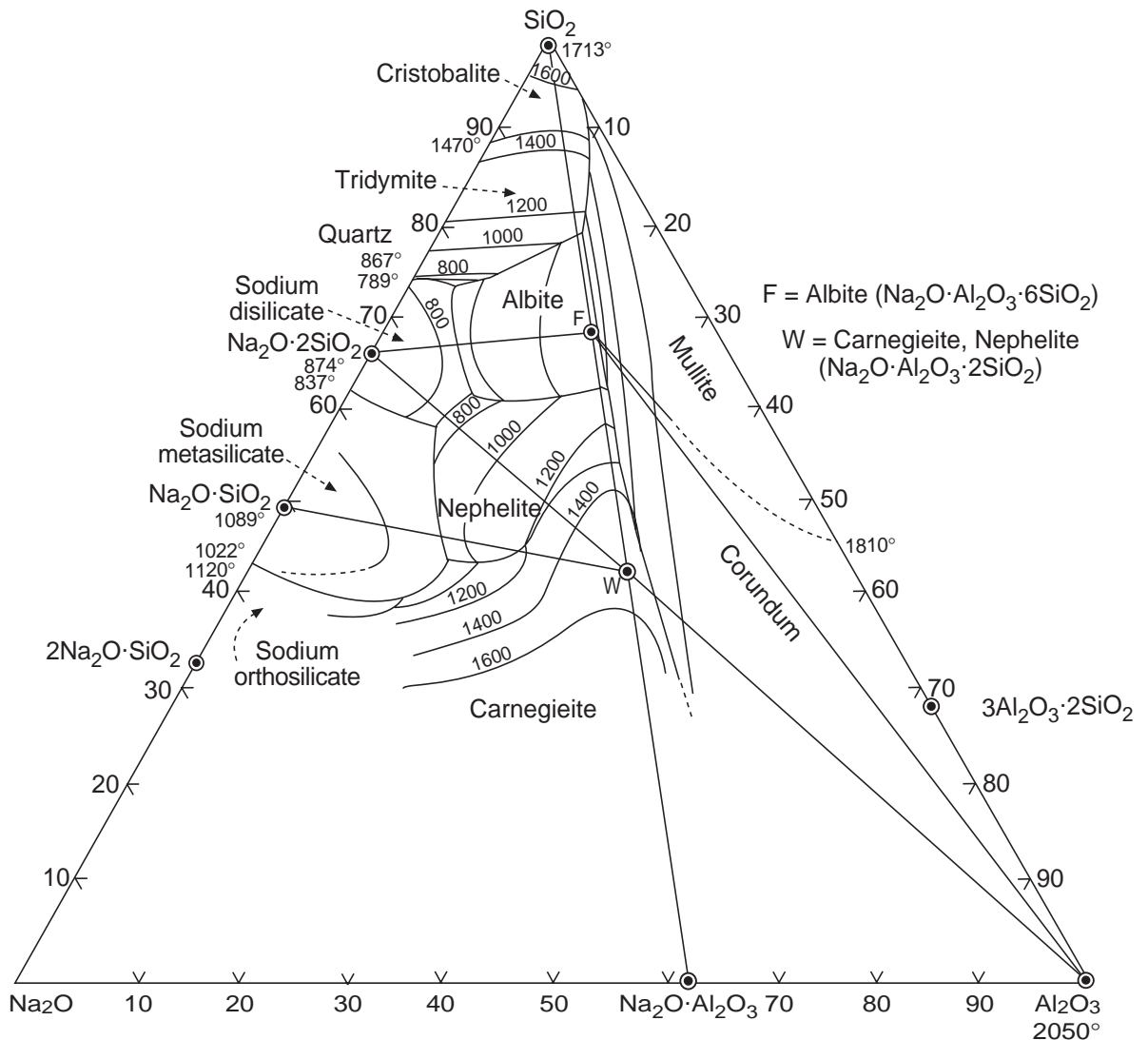


Fig. 3.31 The  $K_2O-Al_2O_3-SiO_2$  system.

Low levels of impurities are far more critical in silica brick than fireclay brick, and alkalis are the worst offenders. The amounts of  $Na_2O$ ,  $K_2O$ , and  $Al_2O_3$  required to lower the melting point of pure silica from about  $1725^\circ C$  to about  $1675^\circ C$  (about  $3140^\circ F$  to about  $3050^\circ F$ ) are, respectively 1.4, 1.9, and 3.1%.

Another very deleterious fluxing agent for fireclay refractories is  $MnO$ , as can be seen in the diagram of the  $MnO-Al_2O_3-SiO_2$  system in Fig. 3.33. Note that this system is quite similar to the  $FeO-Al_2O_3-SiO_2$  system.

Because the raw materials for silica brick lack both a natural bond and a high melting point, care must be taken that the required bonding addition has the minimum effect on refractoriness. Fig. 3.34 shows the  $CaO-SiO_2$  system and explains why lime is universally used for this purpose. With additions of  $CaO$  to  $SiO_2$ , the melting temperature remains unchanged between 1 and 27.5%  $CaO$ , due to the formation of two immiscible liquids. No such phenomenon occurs in the  $Al_2O_3-SiO_2$  system, and by referring again to the  $CaO-Al_2O_3-SiO_2$  system, it is found that only a small amount of  $Al_2O_3$  is required to destroy the  $CaO-SiO_2$  immiscibility. In fact the effect of minor increments

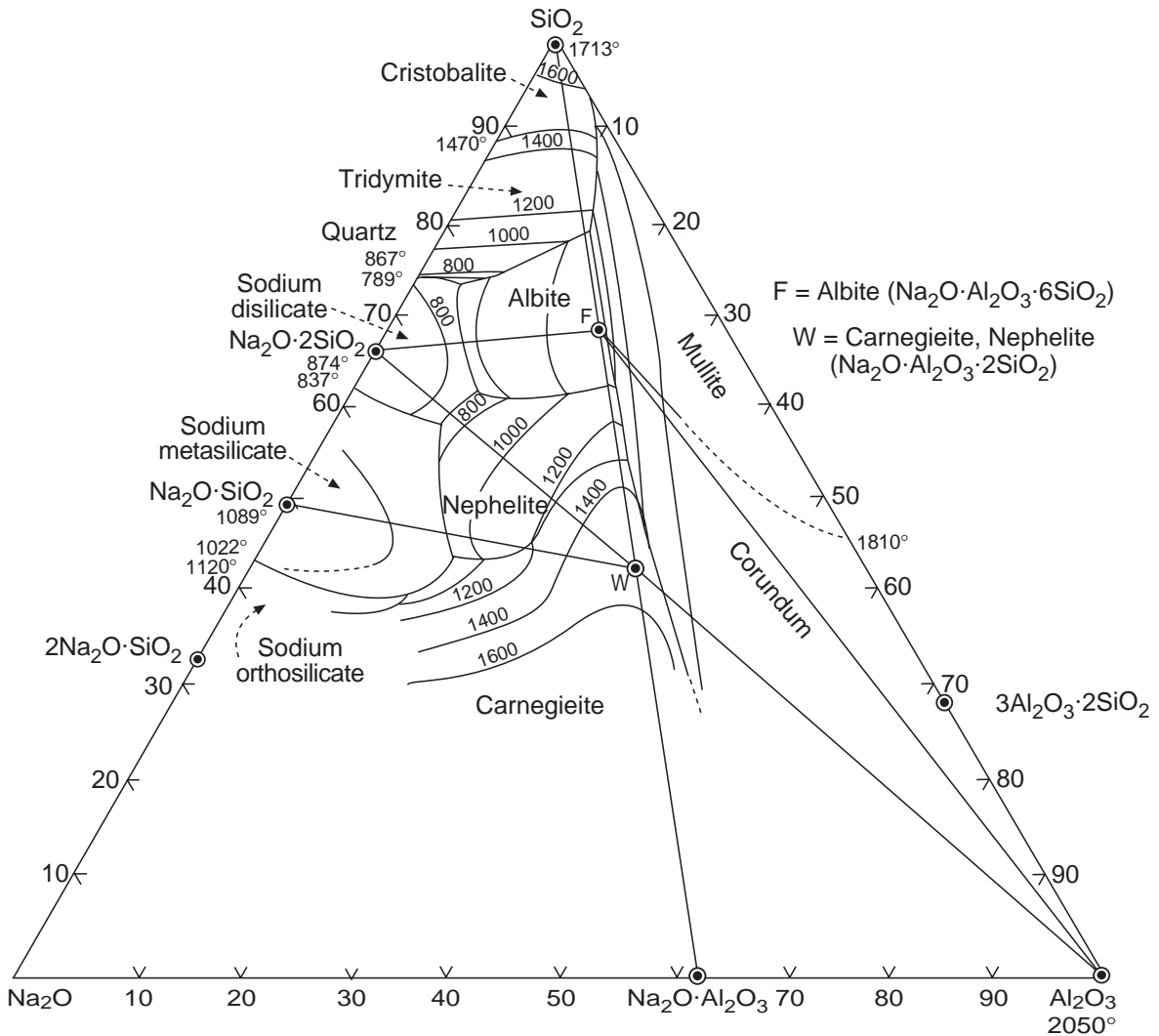


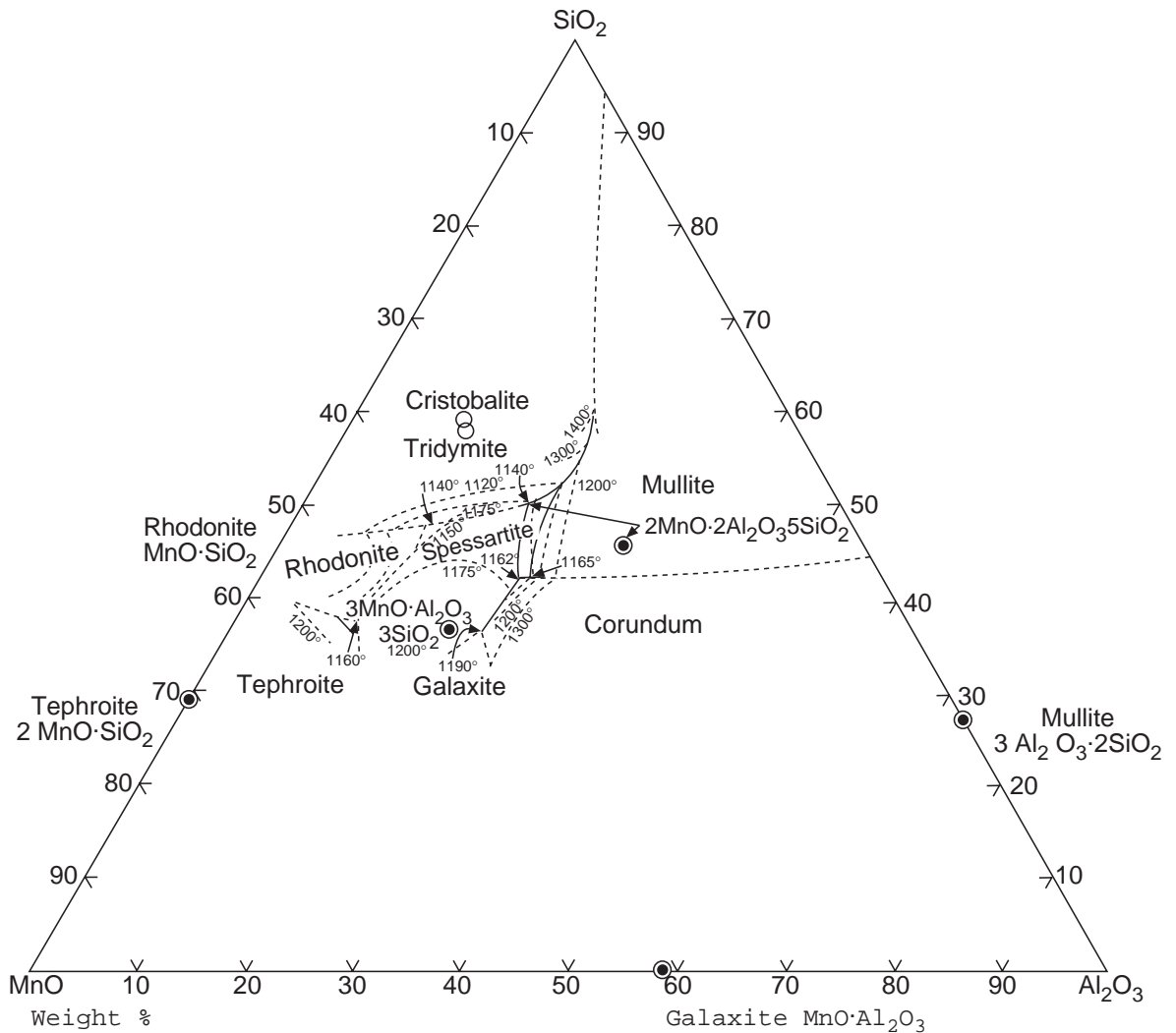
Fig. 3.32 The  $\text{Na}_2\text{O}-\text{Al}_2\text{O}_3-\text{SiO}_2$  system.

of  $\text{Al}_2\text{O}_3$  on the liquid development of silica brick is such that the temperature of failure under a load of 172 kPa (25 psi) will decrease approximately  $5^\circ\text{C}$  ( $10^\circ\text{F}$ ) for each 0.1% increase in  $\text{Al}_2\text{O}_3$  in the 0.3 to 1.2% range of  $\text{Al}_2\text{O}_3$  between super duty and conventional silica brick. Fig. 3.35 of the  $\text{FeO}-\text{SiO}_2$  system shows that  $\text{FeO}$ , like  $\text{CaO}$ , also forms two immiscible liquids when added to  $\text{SiO}_2$ , thus greatly increasing the tolerance of silica brick for  $\text{FeO}$ . Furthermore, as with  $\text{CaO}$ , a small amount of  $\text{Al}_2\text{O}_3$  can eliminate this immiscibility.

As atmospheric conditions in steelplant furnaces may range from highly reducing to highly oxidizing, the form of iron oxides present may vary from  $\text{FeO}$  to  $\text{Fe}_2\text{O}_3$ . Accordingly, Fig. 3.36 shows the system  $\text{FeO}-\text{Fe}_2\text{O}_3-\text{SiO}_2$  and is of considerable importance in understanding the behavior of silica brick in service. Thus, it is seen that the lowest-melting liquids occur from reaction of  $\text{FeO}$  and  $\text{SiO}_2$ , and that at temperatures in the range of  $1455-1665^\circ\text{C}$  ( $2650-3030^\circ\text{F}$ ) less liquid, and a less siliceous liquid, will be produced with either  $\text{FeO}\cdot\text{Fe}_2\text{O}_3$ , or  $\text{Fe}_2\text{O}_3$  than with  $\text{FeO}$ , due to the greater extent of the two liquid region under oxidizing conditions.

The two principal refractory oxides considered to be basic are magnesia ( $\text{MgO}$ ) and calcia ( $\text{CaO}$ ). Magnesia is noted for its tolerance to iron oxides. As shown in Fig. 3.37,  $\text{MgO}$  and  $\text{FeO}$  form a





**Fig. 3.33** The MnO-Al<sub>2</sub>O<sub>3</sub>-SiO<sub>2</sub> system.

continuous series of solid solutions which have high refractoriness even with very high FeO contents. Under oxidizing conditions, magnesia is even more tolerant to iron oxide. Magnesia and iron oxide form the refractory compound magnesioferrite (MgO·Fe<sub>2</sub>O<sub>3</sub>) which contains 80 wt% Fe<sub>2</sub>O<sub>3</sub>. Magnesioferrite forms solid solutions with magnetite (FeO·Fe<sub>2</sub>O<sub>3</sub>) at higher iron oxide contents and with magnesia at lower iron oxide contents. On the other hand, calcia is more reactive with iron oxide, forming low melting calcium ferrites such as dicalcium ferrite (2CaO·Fe<sub>2</sub>O<sub>3</sub>) that melts incongruently at ~1440°C (~2620°F). Also, calcia is subject to hydration and disruptive disintegration on exposure to atmospheric conditions and cannot be used in refractory shapes made by conventional procedures. It is evident, therefore, that magnesia is the more useful basic refractory oxide and forms the base for all types of basic refractories including those made from magnesite, olivine, dead burned dolomite, and magnesite and chrome ore.

Magnesia-bearing refractories, regardless of type, contain accessory refractory oxides and encounter other refractory oxides in service which exert an important influence on their performance. Fig. 3.38 shows the reactions and phase assemblages in the MgO-CaO-SiO<sub>2</sub> system. In the high MgO portion of this system, the principal mineral is of course always periclase. The accessory

Fig. 3.34 The CaO–SiO<sub>2</sub> system.

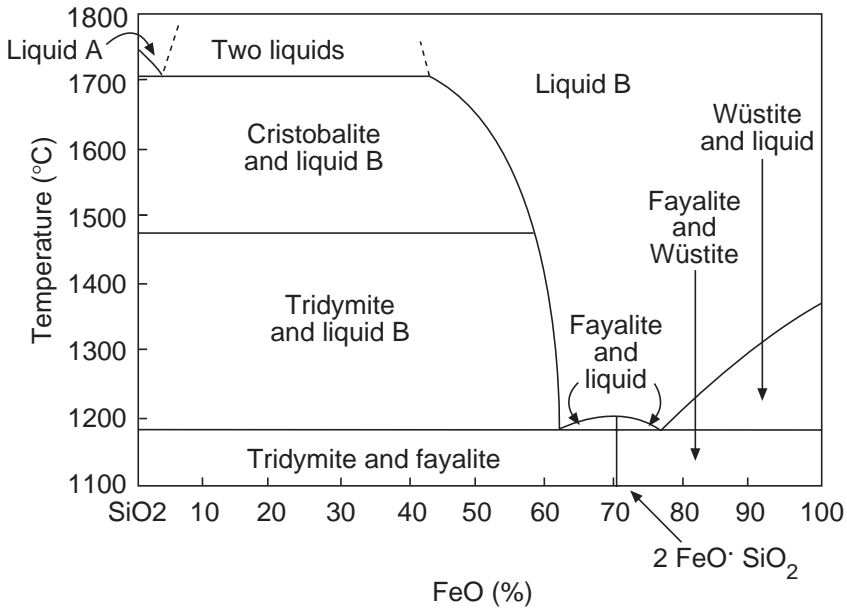
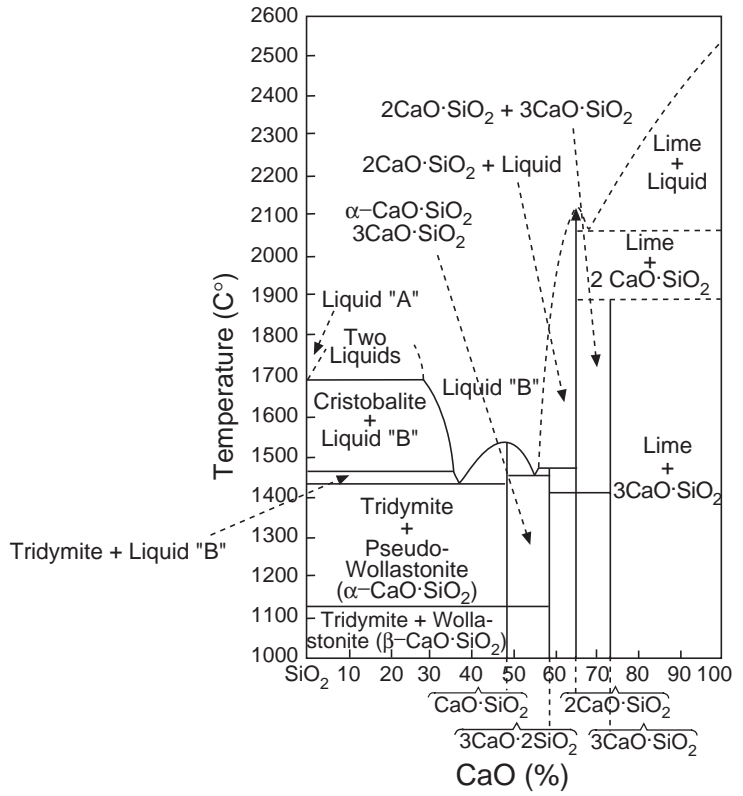


Fig. 3.35 The FeO–SiO<sub>2</sub> system.

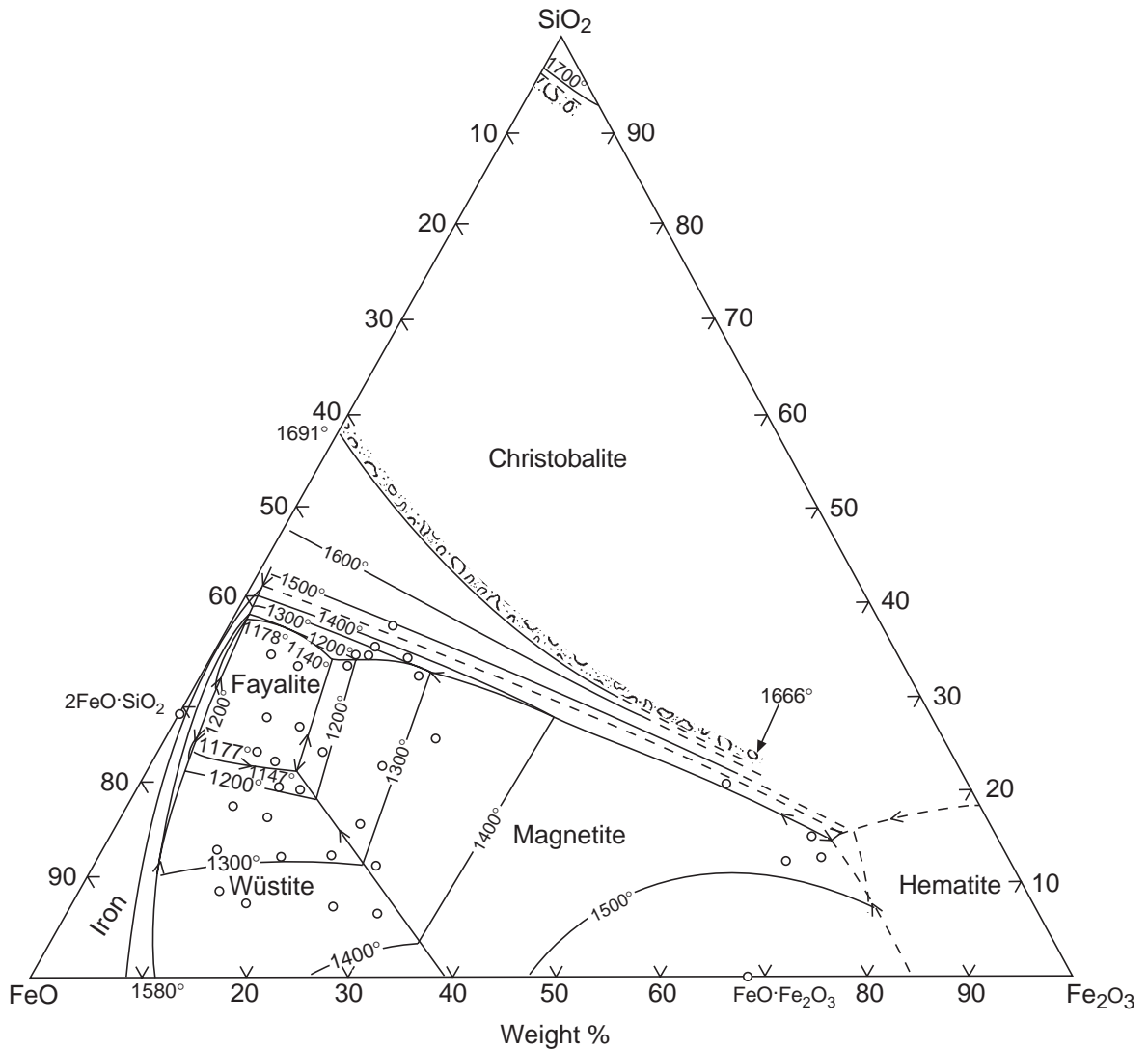


Fig. 3.36 The FeO-Fe<sub>2</sub>O<sub>3</sub>-SiO<sub>2</sub> system.

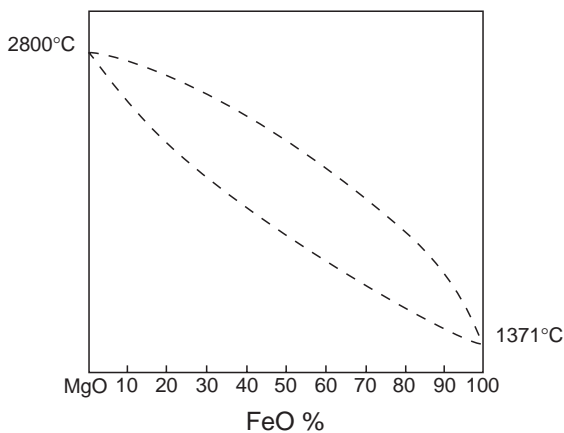


Fig. 3.37 The MgO-FeO system.

silicate bonding minerals, however, will vary considerably depending on the ratio of CaO to SiO<sub>2</sub>. Table 3.30 presents a summary of the compounds present with periclase as affected by the CaO/SiO<sub>2</sub> weight ratio and their approximate melting points. The type of refractory bonding preferred will depend on the intended application. The forsterite bond, which occurs at CaO/SiO<sub>2</sub> ratios less than 0.93, is desired in some basic brick to prevent excessive formation of monticellite and merwinite. These minerals form low temperature liquids and therefore have poor high temperature load carrying ability. Refractory bonding phases with high melting points can also



**Table 3.30 Mineral Phases in Equilibrium with Periclase (MgO) in the MgO–CaO–SiO<sub>2</sub> System**

Weight Ratio CaO/SiO <sub>2</sub>	Minerals Present	Composition	Approximate Melting Temperature (°C)
less than 0.93	Forsterite	2MgO•SiO <sub>2</sub>	1900
	Monticellite	CaO•MgO•SiO <sub>2</sub>	1490*
0.93	Monticellite	CaO•MgO•SiO <sub>2</sub>	1490*
0.93 to 1.40	Monticellite	CaO•MgO•SiO <sub>2</sub>	1490*
	Merwinite	3CaO•MgO•2SiO <sub>2</sub>	1575*
1.40	Merwinite	3CaO•MgO•2SiO <sub>2</sub>	1575*
1.40 to 1.86	Merwinite	3CaO•MgO•2SiO <sub>2</sub>	1575*
	Dicalcium silicate	2CaO•SiO <sub>2</sub>	2130
1.86	Dicalcium silicate	2CaO•SiO <sub>2</sub>	2130
1.86 to 2.80	Dicalcium silicate	2CaO•SiO <sub>2</sub>	2130
	Tricalcium silicate	3CaO•SiO <sub>2</sub>	1900**
2.80	Tricalcium silicate	3CaO•SiO <sub>2</sub>	1900**
More than 2.80	Tricalcium silicate	3CaO•SiO <sub>2</sub>	1900**
	Lime	CaO	2565

\*Incongruent melting

\*\*Stable only between 1900° and 1250°C.

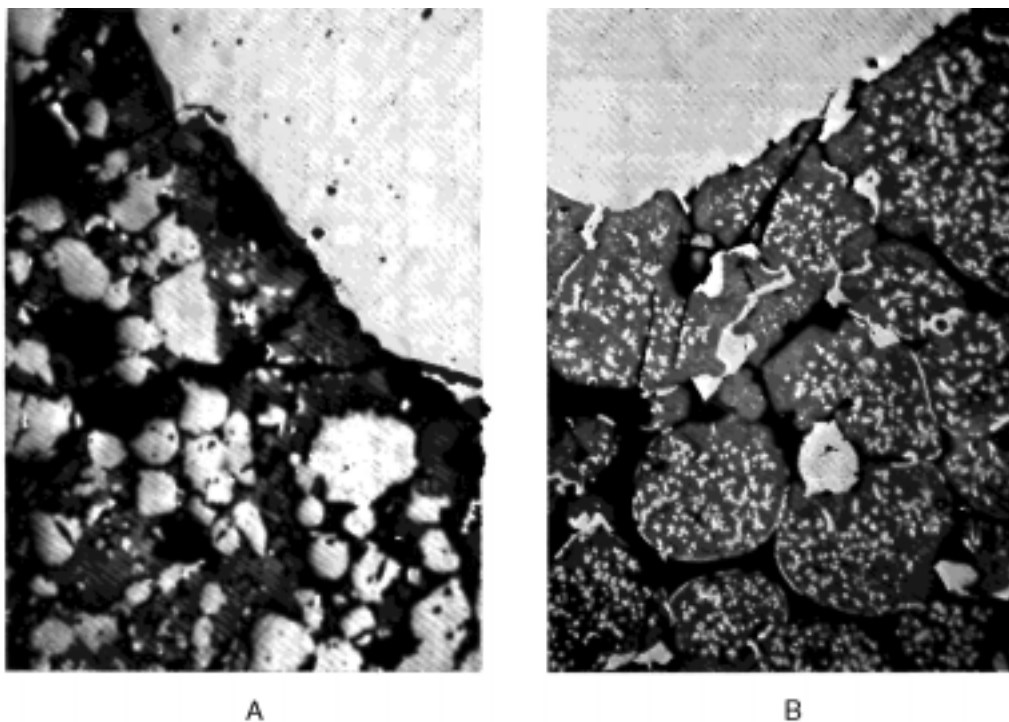
Dissociation below and above these temperature into 2CaO•SiO<sub>2</sub> and CaO.

to chrome ore, however, the gangue silicates are converted on firing during manufacture or in service to the more refractory phases such as forsterite or dicalcium silicate, and the iron oxide to the spinel MgO·Fe<sub>2</sub>O<sub>3</sub> by co-diffusion of Fe<sub>2</sub>O<sub>3</sub> and MgO between the magnesia and chrome spinel. MgO·Fe<sub>2</sub>O<sub>3</sub> is more resistant to deterioration in cyclic oxidizing and reducing conditions than the iron oxides in the original chrome ore. The addition of still greater amounts of magnesia to chrome ore improves significantly the resistance of the refractory to iron oxide bursting because of the greater affinity of magnesia for iron oxide as compared with Cr<sub>2</sub>O<sub>3</sub>. The addition of chrome ore to magnesia on the other hand improves the resistance of magnesia to thermal spalling through an apparent stress relief in an otherwise rigid structure.

As in magnesia refractories, the CaO/SiO<sub>2</sub> ratio exerts an important influence on the phases present in composite refractories of magnesia and chrome ore. At CaO/SiO<sub>2</sub> ratios less than 1.86, the primary phases between MgO, CaO, and SiO<sub>2</sub> are the same as that previously discussed with the sesquioxides Cr<sub>2</sub>O<sub>3</sub>, Al<sub>2</sub>O<sub>3</sub>, and Fe<sub>2</sub>O<sub>3</sub> combined with MgO and FeO to form spinel solid solutions. At higher CaO/SiO<sub>2</sub> ratios, the sesquioxides form low melting compounds with CaO.

As in magnesia refractories, efforts have been made to replace the silicate bond in refractories made from magnesia and chrome ore. The most noteworthy of these efforts to date is the use of firing temperatures above those normally employed to produce a low silica burned basic refractory with so-called direct bonding of the magnesia. Fig. 3.39 shows photomicrographs of the conventional silicate and these direct bonds, respectively. Direct-bonded brick have usually high hot strengths, several times that of conventional brick of similar composition.

Although the phase assemblages previously discussed indicate the general combinations of iron oxides in basic refractories, it is equally important to consider the influence of furnace temperature and atmosphere on the oxidation state of the iron present in various compositions including the oxides MgO, Cr<sub>2</sub>O<sub>3</sub>, Al<sub>2</sub>O<sub>3</sub>, FeO, and Fe<sub>2</sub>O<sub>3</sub>. It has been shown, for example, that in mixtures consisting originally of Fe<sub>2</sub>O<sub>3</sub> and MgO·Fe<sub>2</sub>O<sub>3</sub>, dissociation of the Fe<sub>2</sub>O<sub>3</sub> is accompanied by solution of the dissociation product magnetite (FeO·Fe<sub>2</sub>O<sub>3</sub>) in MgO·Fe<sub>2</sub>O<sub>3</sub> until a single spinel phase is

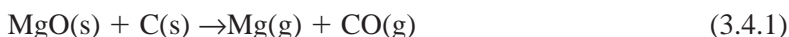


**Fig. 3.39** Photomicrographs showing the structure of basic brick with different bonds. Photomicrograph A is a magnesite-chrome ore composition in which the bond between the large white chrome spinel grains and rounded magnesia crystals is principally the dark silicate. Photomicrograph B shows a magnesite-chrome composition having less silicate and a direct bond between white chrome spinel and periclase (MgO) containing multiple white magnesioferrite inclusions. Reflected light, 200X.

formed. In this same region, it has been shown that the spinel to sesquioxide transition temperature decreases as the magnesia content increases, but at the same time magnesia stabilizes  $\text{Fe}_2\text{O}_3$  at higher temperatures. Chrome oxide ( $\text{Cr}_2\text{O}_3$ ), on the other hand, has an opposite effect to magnesia in that it increases the sesquioxide to spinel transition temperature and lowers the degree of dissociation of  $\text{Fe}_2\text{O}_3$  at higher temperatures. In mixtures consisting initially of  $\text{MgO}\cdot\text{Fe}_2\text{O}_3$  and  $\text{MgO}$ , dissociation of  $\text{Fe}_2\text{O}_3$  proceeds with a decrease in the amount of spinel and solution of iron oxide in periclase.

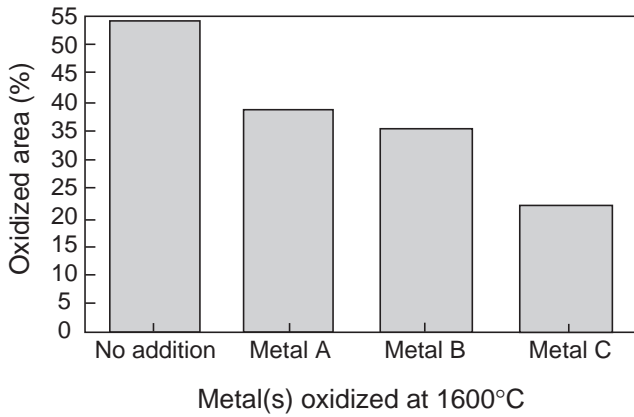
With the advent of carbon bonded refractories and oxide carbon refractories, the study of oxide reducing, gas-solid reactions has become an important concern for refractory technologists. Three main subjects are important: the straight or the direct oxidation of carbon (and graphite) by air; the reduction of magnesia (and other oxides) by carbon (graphite); and the role of antioxidants.

The rate of the magnesia-carbon reaction below is mainly affected, in addition to temperature, by the purity and the crystal size of the magnesia grain.



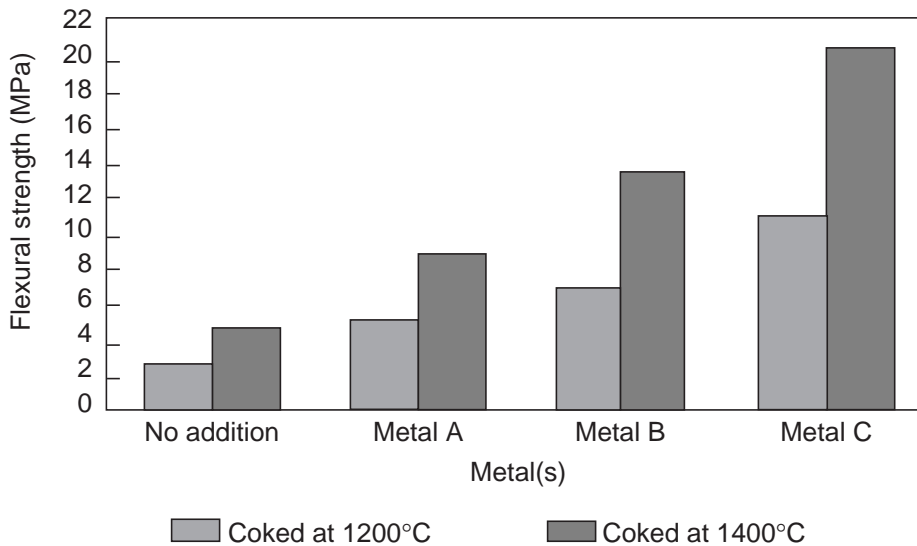
This reaction reduces the magnesia to Mg vapor, which migrates to the surface, oxidizes, and forms a dense MgO zone or is incorporated in the furnace atmosphere. The dense zone may have a positive effect on the resistance to slag attack and oxidation resistance, but, on the other hand, the loss of refractory ingredients due to the  $\text{MgO}\text{--C}$  reaction results in a porous matrix behind the hot face which can be easily penetrated by slag at a later stage.

Antioxidants as metals (Mg, Al, Si) or carbides ( $\text{SiC}$ ,  $\text{B}_3\text{C}$ ) are often used to improve refractory properties such as oxidation resistance. Metals are added as antioxidants due to the fact that the



**Fig. 3.40** Effect of metal(s) addition on resistance to oxidation. From Ref. 2.

affinity of some metals to oxygen, at the critical temperature range, is stronger than that of carbon. Each metal, or metal combination, has a different oxidation resistance characteristic as shown in Fig. 3.40. By protecting the graphite and the bond network from oxidation, and through the formation of carbides and nitrides, the metals improve the elevated temperature strength, in air, and under reducing atmospheres; see Fig. 3.41. Moreover, once the graphite is oxidized, there is no barrier preventing the magnesia grain from being washed into the slag; therefore, by protecting the graphite from oxidation, the metals also improve the resistance to slag attack.



**Fig. 3.41** Effect of metal(s) addition on coked strength. From Ref. 2.

Results of thermodynamic calculations of magnesia carbon refractories are summarized in Table 3.31. In this table Zone I is at the refractory hot face and Zone V is at the cold face. The oxides are to be found in a decarburized zone at the hot face. In the next zone, metal oxidation should be occurring together with the formation of secondary carbon from CO present inside of the brick matrix. This secondary carbon could produce extremely low porosity and a low permeable zone that precludes gas penetration and slag infiltration into the brick matrix. When CO is completely used up and only  $N_2$  is available, the latter gas will form  $AlN$  and  $Mg_3N_2$ , respectively.

Carbides of Al, Si, and perhaps Mg can be formed by direct reaction between the respective metal and carbon further from the hot face. Thermodynamically, the effectiveness of the metals as antioxidants should be in the order Si–Al–Mg, least to most. Experimental data showed, however, that the order is reversed and does not follow oxygen affinity to the metals.

**Table 3.31 Reaction Products for Three systems: MgO + Al + C, MgO + Mg + C, and MgO + Si + C at Different Temperatures Throughout a BOF Lining****Zone I (CO<sub>2</sub>, CO, N<sub>2</sub>)**

MgO + MA MA = MgO Al <sub>2</sub> O <sub>3</sub> (Spinel)	MgO	MgO + M <sub>2</sub> S M <sub>2</sub> S = 2MgO SiO <sub>2</sub>
---	-----	--

**Zone II (CO, N<sub>2</sub>)**

> 2080K: MgO + AlN + C	MgO	> 1800K: MgO + M <sub>2</sub> S + C
< 2080 K: MgO + MA + C		< 1800K: MgO + SiC + C

**Zone III (N<sub>2</sub>)**

MgO + AlN + C	> 1600K: MgO + Mg + C	> 1700K: MgO + SiC + C
	< 1600K: MgO + Mg <sub>3</sub> N <sub>2</sub> + C	< 1700K: MgO + Si <sub>3</sub> N <sub>4</sub> + C

**Zone IV  
(Neutral Atmosphere)**

> 1380K: MgO + Mg + C	MgO + Mg + C	> 1810K: MgO + M <sub>2</sub> S + Mg + C
< 1380 MgO + Al <sub>4</sub> C <sub>3</sub> + C		< 1810K: MgO + SiC + C

**Zone V  
(Unchanged Material)**

MgO + Al + C	MgO + Mg + C	MgO + Si + C
--------------	--------------	--------------

From Ref. 2.

## 3.5 Testing and Selection of Refractories

### 3.5.1 Simulated Service Tests

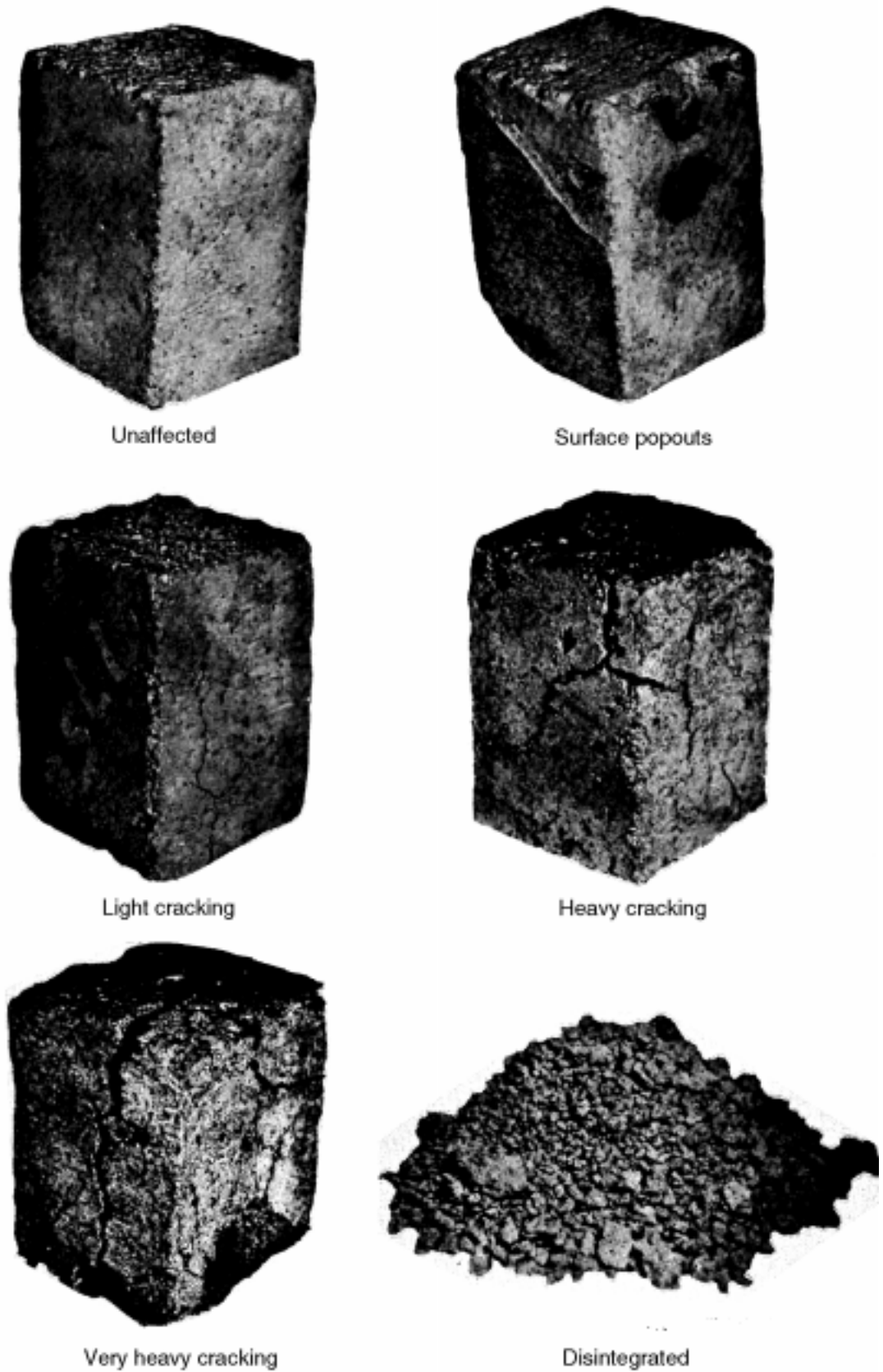
Section 3.3 described various tests for single refractory properties. Because most refractories wear by a complex combination of mechanisms, many simulated tests have been developed to study refractory behavior for specific applications.

One simple example includes failure of refractories in a special gaseous environment such as carbon monoxide. Carbon monoxide disintegration occurs as carbon from the CO gas deposits around iron concentrations in a refractory:



The iron concentrations catalyze this reaction, producing carbon buildups and growth on iron locations which may fracture the refractory behind the hot face (the above reaction is highly temperature sensitive). Simulative tests have been designed to predict resistance to carbon monoxide disintegration in all types of refractories by heating the refractory for long periods in CO gas. Fig. 3.42 shows refractory samples after such tests. Although refractories without iron will not be affected by this reaction, the total removal of iron from most natural raw material is not economically practical. A more practical solution involves proper handling of raw materials and processes to remove ternary iron and minimize iron contamination from grinding. Control of the form of iron in the fired aggregate in monolithic materials or fired products has led to the development of special low iron refractories for blast furnace linings. Grinding equipment improvements and magnetic





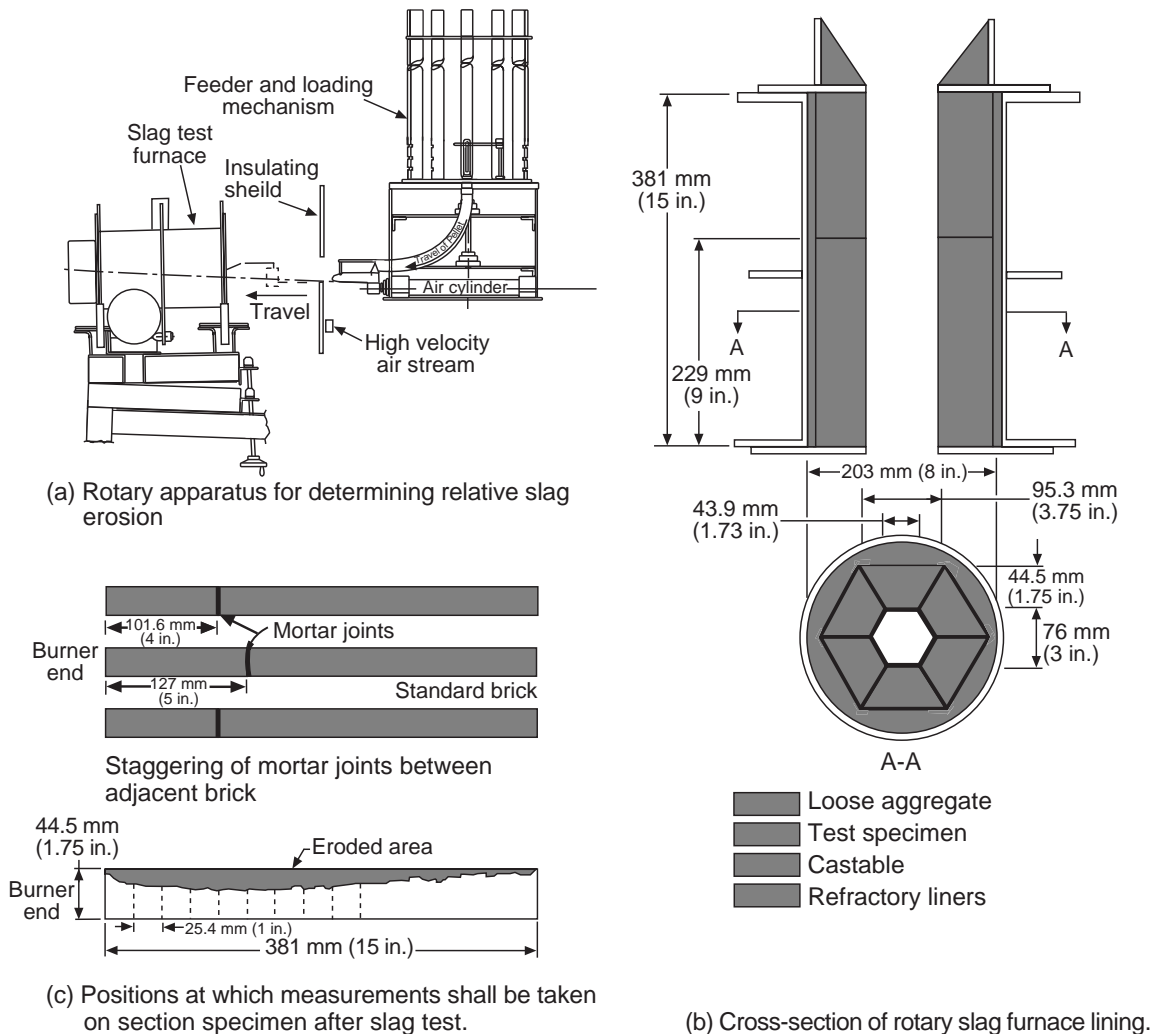
**Fig. 3.42** Specimen rating after the carbon monoxide disintegration test.

separation have further been used to minimize contamination. Examples of other simple simulated service tests include testing for exposure to alkalis, hydration, sulfidation, or oxidation.

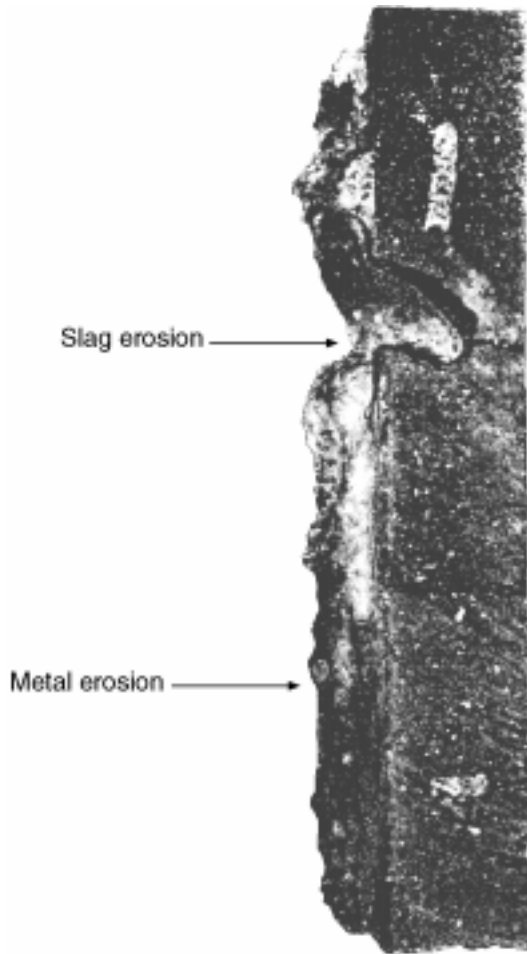
Many more complex simulative tests exist where various failure mechanisms may be simulated at one time. For example, refractory samples may be exposed to slags in a rotating furnace heated with an oxygen-gas torch as shown in Fig. 3.43 (a), (b), and (c). In this test refractory wear from chemical reaction with the molten slag, erosion by slag, thermal cycling, and other effects can be measured for various times, temperatures, and atmospheres.

Similar slag tests are conducted using a metal induction furnace with the specimen as part of the lining. In this case, wear by both metal and slag can be obtained on the same refractory specimens, as illustrated in Fig. 3.44.

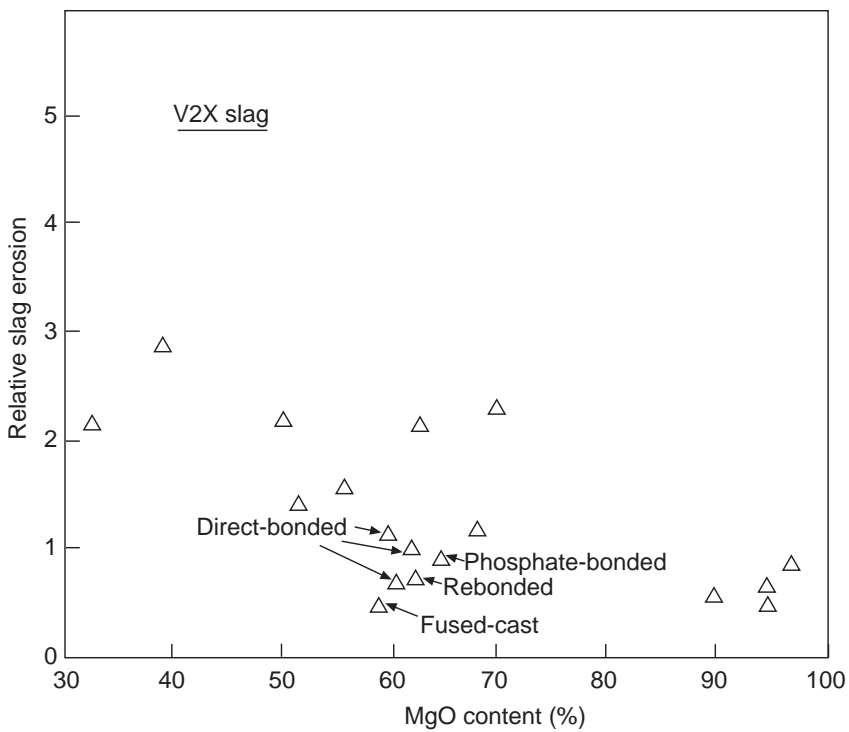
The results from such tests can usually be correlated with the overall composition, with specific additives to the refractory and with the overall physical characteristics of the refractory. These effects are illustrated in Fig. 3.45 through Fig. 3.47. The slag resistance of various basic brick are



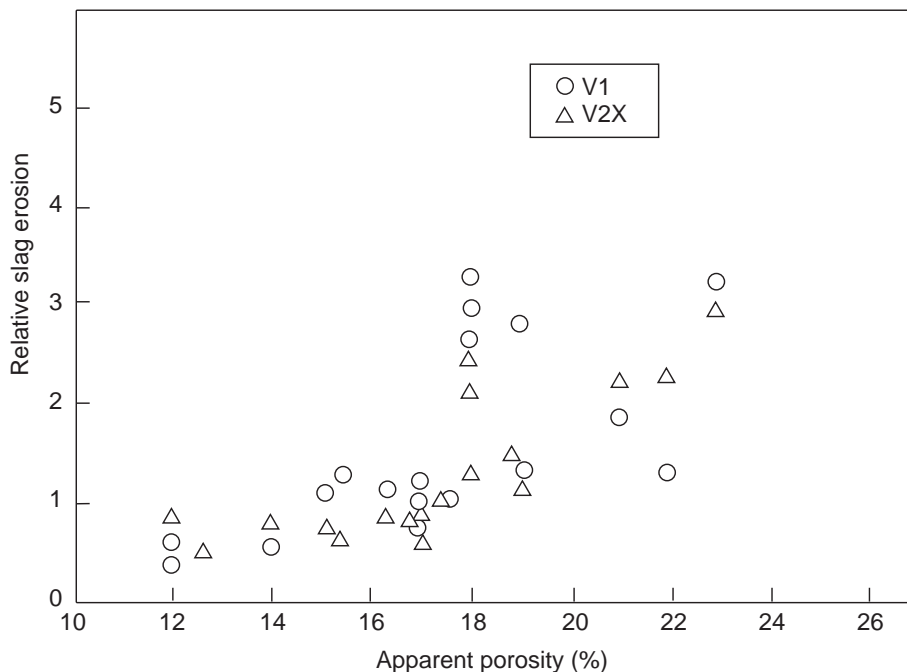
**Fig. 3.43** (a) rotary apparatus for determining relative slag erosion, (b) cross section of rotary slag furnace lining, (c) positions at which measurements shall be taken on section specimen after slag test.



**Fig. 3.44** Sectioned sample after slag test showing high erosion (1.27 in<sup>2</sup>).



**Fig. 3.45** Relation of relative slag erosion in rotary test to MgO content for various basic brick.



**Fig. 3.46** Effect of porosity on relative slag erosion in rotary test of various basic brick with indicated slag compositions.

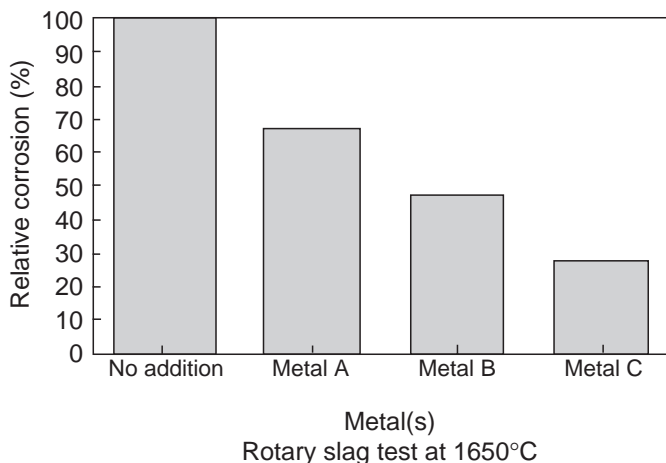
shown to be related to brick composition (MgO content) and physical structure (apparent porosity) and the slag resistance of a magnesia carbon brick is related to the type of metal antioxidant used.

Refractory specimens may also be exposed to erosion and thermal shock by dipping or spinning in steel baths or by pouring steel on or through them. For example, Fig. 3.48 shows steel pouring tubes after testing in steel while they were rotated at various speeds to simulate steel flowing through the exit ports.

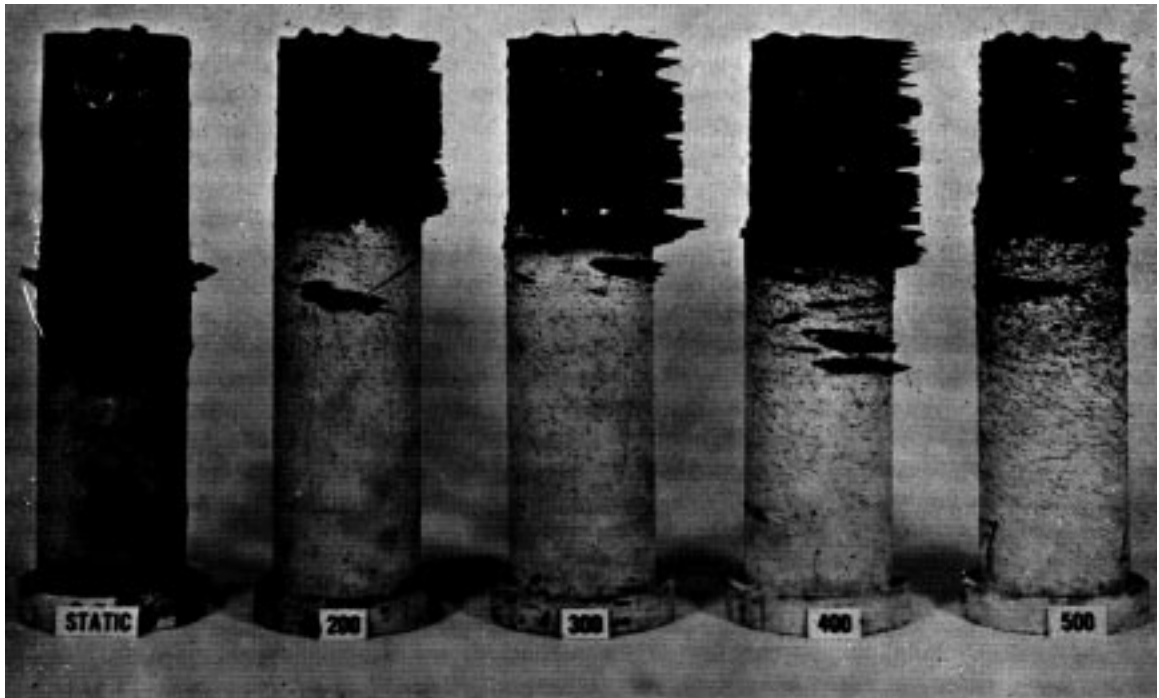
It should always be remembered that any of the simulated refractory tests fail to some degree to duplicate service conditions. Fig. 3.49 is an effort to fully characterize the slag-refractory reaction involving wear by corrosion, penetration and dissolution.

What makes corrosion resistance so difficult to measure is the fact that this characteristic is also a matter of the composition of the slags and their fluidity or viscosity, surface tension, wettability and work of adhesion, thermal conductivity, mass conductivity and density.

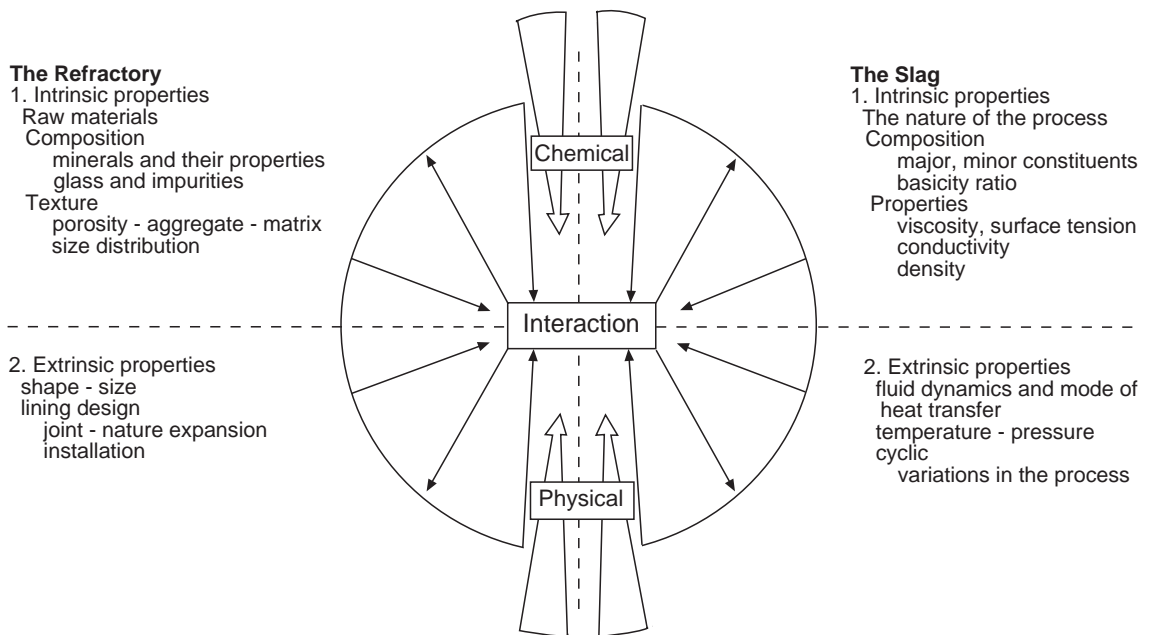
The extrinsic properties of both the refractory and the slag are also important parameters to define shape and size of the bricks, lining design, nature of the joints, expansion joints, and method of refractory installation, on one hand; fluid dynamics, heat and mass transport phenomena at the



**Fig. 3.47** Effect of metal(s) addition on corrosion resistance. From Ref. 2.



**Fig. 3.48** One brand of pouring tubes after testing of various speeds for one hour in C 13450 (AISI 1345) steel.



**Fig. 3.49** Parameters influencing the slag-refractory reaction. Case of pure dissolution. *From Ref. 2.*

refractory-slag interface, temperature, pressure, temperature gradients, concentration gradients, variability, and the cyclic nature of the process, on the other hand.

In porous refractories, corrosion-dissolution is an accompaniment of penetration (chemical invasion) into pores, but also in all openings: at the lining level, in open joints, gaps, and cracks; at the brick level, in connected networks of voids so the texture of refractories and the method of installation are of paramount importance.

Both physical penetration and chemical invasion are favored by effective slag-solid wetting and by low viscosity of the slag. Therefore, the slag chemical composition is also of paramount importance.

Slag corrosion always begins with the dissolution of either the matrix material and/or the aggregates themselves, or, in other words, by the interaction of some minor or major constituents of the refractories with the liquid slag. Dissolution means either the solubility of a solid phase into a liquid phase, or a chemical reaction leading to the disappearance of the original solid phase. Therefore, knowing whether the product is liquid or solid at the prevailing temperature is very important.

### 3.5.2 Post-Mortem Studies

To improve refractory life, the mechanisms by which the refractories are consumed must be fully understood. A considerable and continuing effort has therefore been made to thoroughly analyze used refractories and to integrate this information into improved refractory products. In its simplest form, used refractories are examined by chemical analyses and by microscopic methods. Fig. 3.50 shows results using this approach on two types of brick taken from a BOF furnace after service. In the magnesite brick without pitch (burned product), CaO, FeO, and SiO<sub>2</sub> from the slag have penetrated the brick to a depth of 25 to 75 mm (1 to 3 in.) and altered the microstructure and properties of the refractory. Such a refractory may not wear uniformly due to structural spalling as well as hot face corrosion and erosion. In a similar magnesite brick made with pitch or having retained carbon, penetration has been restricted to an area only a few millimetres thick by the presence of carbon in the brick. The carbon minimizes wetting and causes the formation of a dense impervious layer due to limited MgO volatilization. A carbon bearing refractory of this type wears uniformly by corrosion and erosion. The brick without carbon has been severely altered by slag penetration, diffusion, and reaction with the brick components, whereas penetration has been held to 1 to 2 mm in the carbon bearing brick. Unfortunately, carbon penetration inhibitors cannot be used for all applications because the carbon is easily oxidized in some oxidizing processes.

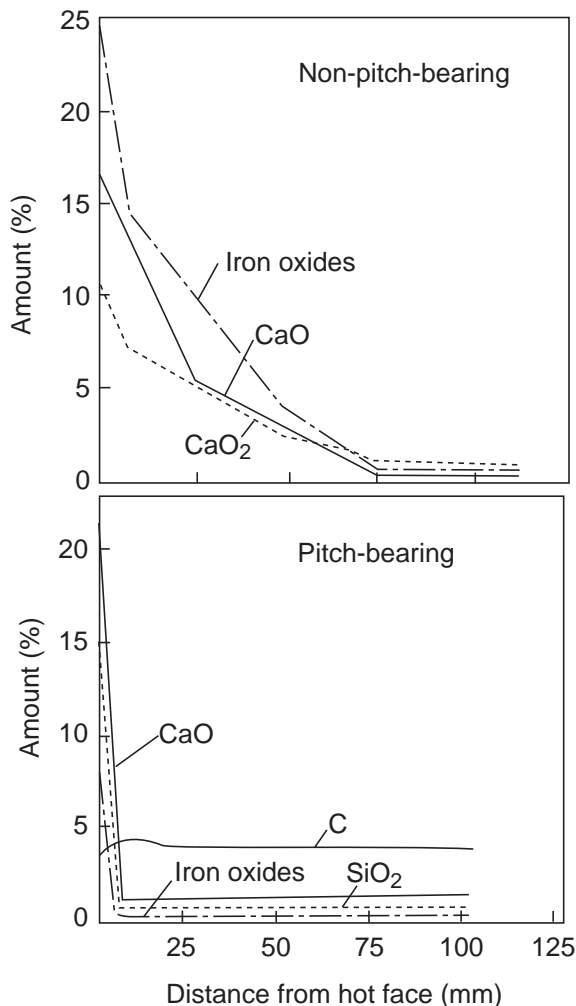
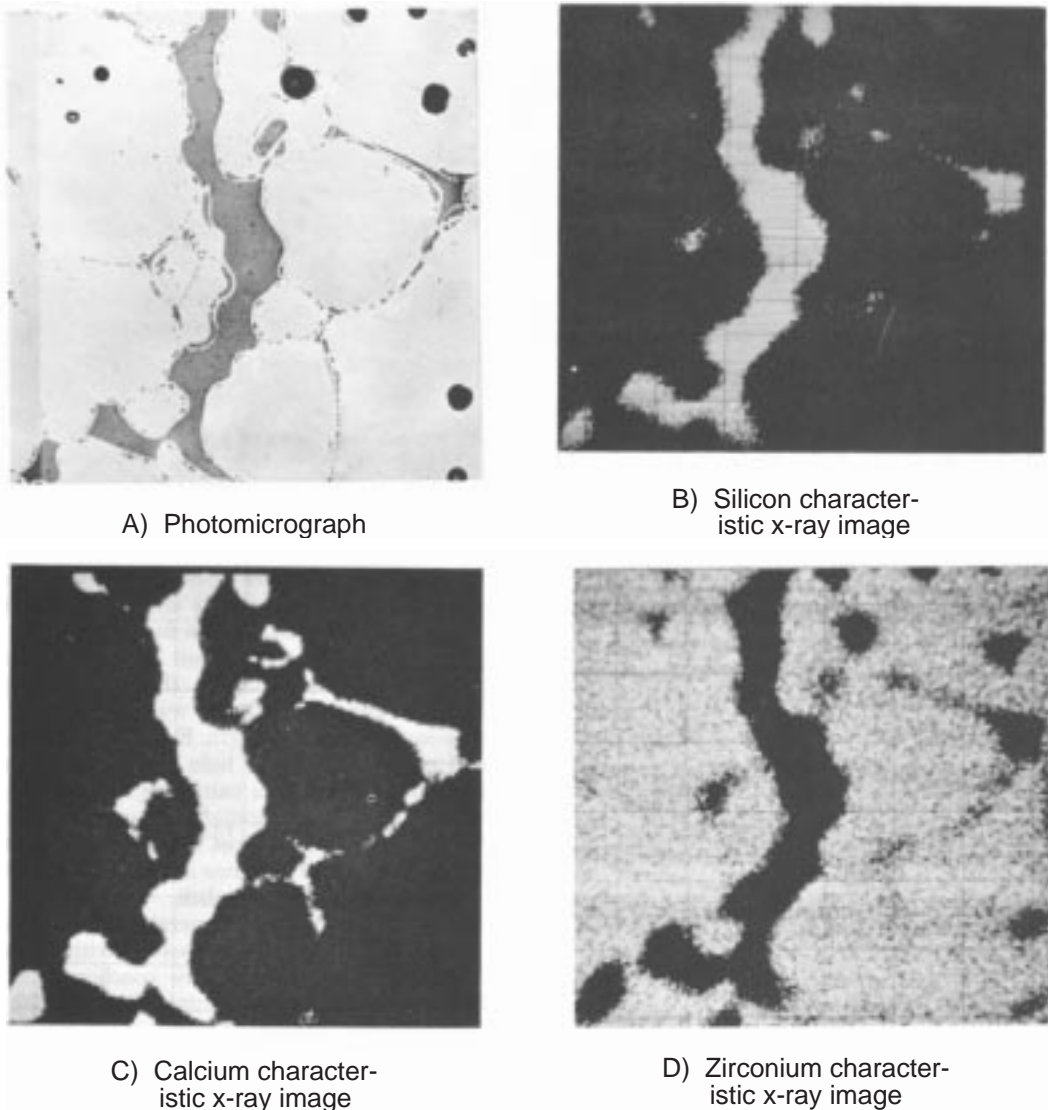


Fig. 3.50 Influence of carbon on slag penetration into magnesite brick in a BOF lining.



**Fig. 3.51** Photomicrograph of center of cross sectioned sensor button showing predominately large grains with glassy material at grain boundaries and characteristic x-ray images (600X) showing distribution of elements.

Many more sophisticated techniques can be used as part of post-mortem examinations including x-ray, scanning electron microscope, or electron probe techniques. Fig. 3.51 illustrated the use of the electron probe to indicate the distribution of impurities in a zirconia refractory. The concentration of impurities in the grain boundary area is typical of refractory material and helps to explain why small quantities of such impurities often produce significant detrimental effects including a significant loss in refractoriness.

### 3.5.3 Thermomechanical Behavior

Studies of the thermomechanical behavior of refractories and refractory lining systems are being used to an increased extent. The availability of larger personal and professional computers and sophisticated software has resulted in increased use of such techniques in refractory design and failure analysis. Compressive static stress/strain data along with compressive creep data, both at realistic stress levels, are required to characterize the mechanical behavior of refractories. Refractory

lining systems are subjected primarily to strain controlled loadings (restrained thermal expansion) and to a much lesser degree stress controlled loadings. As a result, ultimate compressive strain is a better parameter for ranking and selecting the strongest refractory and not the ultimate compressive stress. Methods for measuring strain and creep were briefly described in Section 3.3.5.

The refractory criteria selected for use in these analysis techniques are becoming increasingly realistic. Fig. 3.52 shows calculated results using older elastic modulus data on refractories which gave unrealistically high shell stress values in a steel ladle. These values could be reduced to more realistic (measured) values by adjusting the modulus of elasticity values.

The latest analysis techniques require static compressive stress-strain data and compressive creep data at reasonably high stress levels. Fig. 3.53 shows stress-strain behavior of a high alumina refractory with and without mortar joints, which serve to reduce the stress level for any degree of strain.

Stress analysis can be used to understand and modify observed refractory behavior.

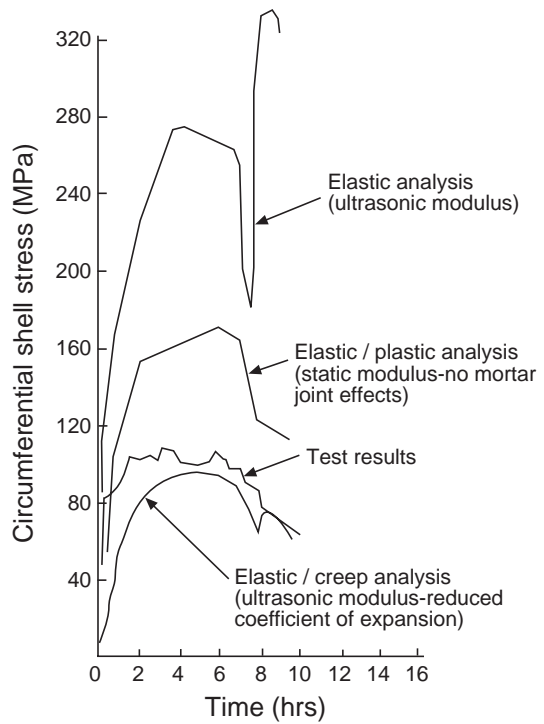


Fig. 3.52 Shell stress versus time. From Ref. 4.

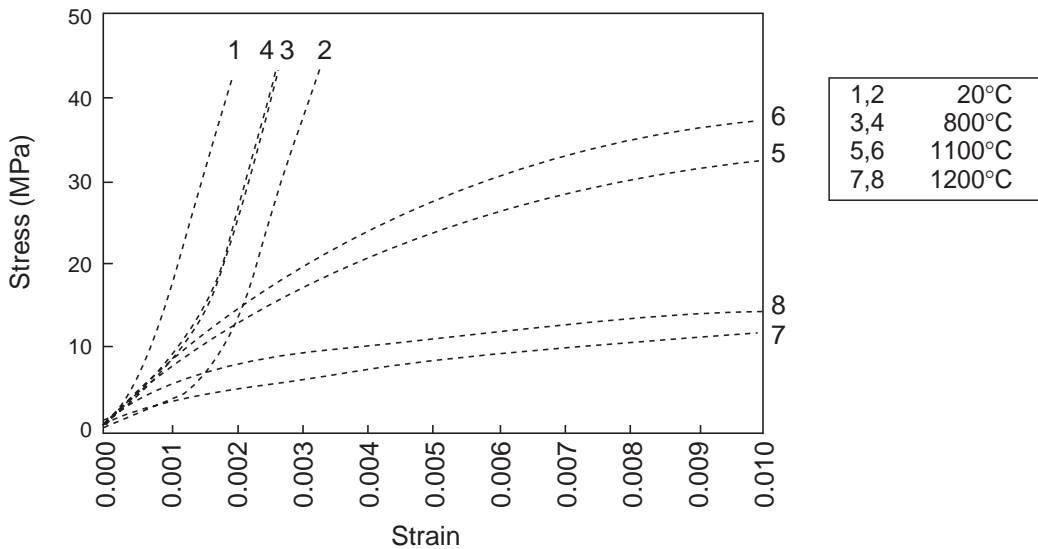
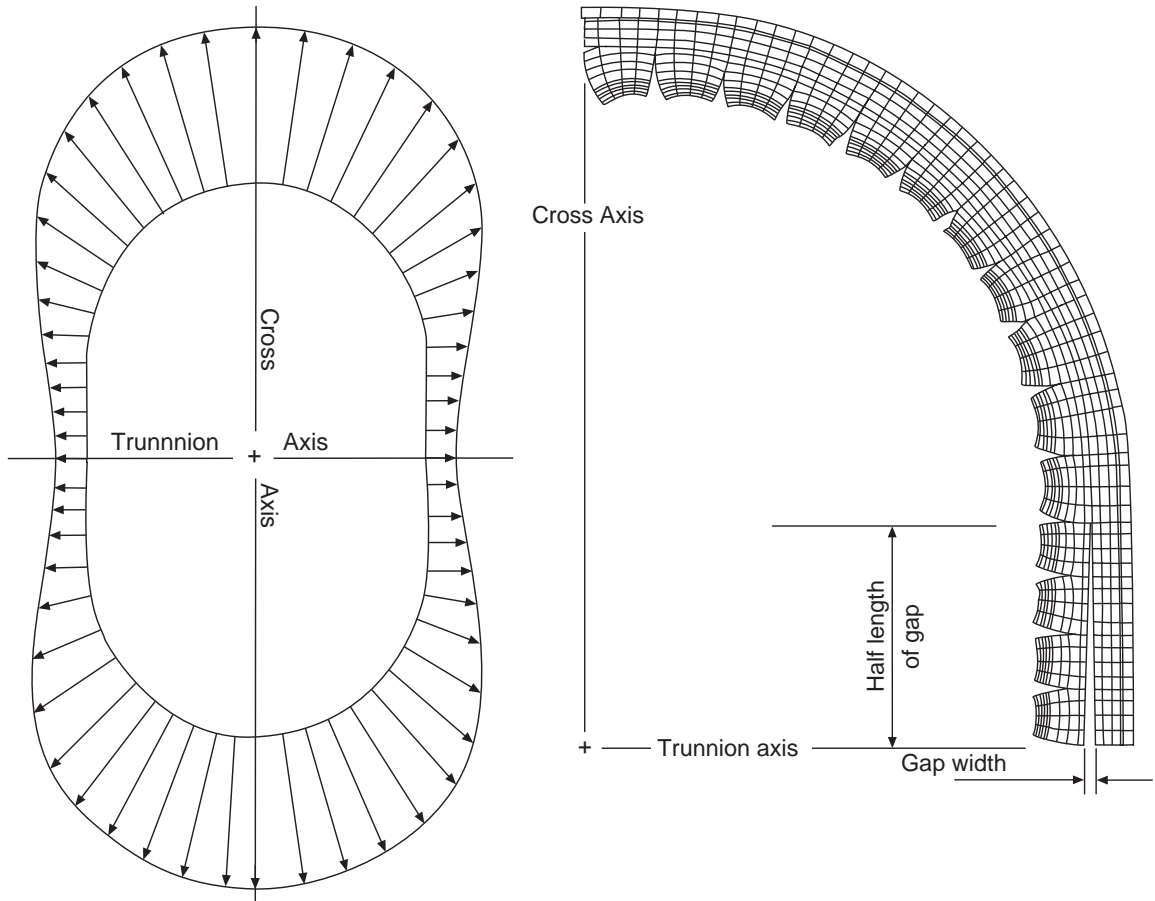


Fig. 3.53 Static compressive stress-strain behavior of a 70% alumina brick with a 1.6 mm brick mortar joint. From Ref. 2

Fig. 3.54 shows the radial compressive load of the working lining against the safety lining that results from the thermal expansion of the ladle refractory brick in an oval shaped ladle. Note that the force imposed by the working lining on the safety lining is greatest in the radial section of the ladle. This compressive force diminishes in the flatter section of the trunnion. Cooling of the refractory between heats causes an inverted thermal gradient through the ladle lining with the brick hot face at a lower temperature than the intermediate temperatures deeper in the lining, as illustrated in Fig. 3.55.





**Fig. 3.54** Illustration of radial compressive load of working lining against the safety lining due to thermal expansion of the working lining. Note the compressive forces are lowest at the trunnion. From Ref. 5.

**Fig. 3.55** Finite element analysis of ladle quarter section after cooling between heats. Note the densification at the hot face due to heating, opening of joints due to shrinkage during cooling, and gap formation at the trunnion. From Ref. 5.

These mechanisms help explain the problems experienced by oval type ladles in the ladle straight sections. Varying material expansion under load characteristics can reduce such problems.

## 3.6 General Uses of Refractories

Other chapters of this book cover the uses of refractories in specific applications. This section is intended to offer only a flavor of refractory uses along with general comments.

### 3.6.1 Linings

The most common type of installation involves a refractory lining to contain molten metal and slag. Such linings are made of several types of refractories to resist specific conditions and usually consist of a working or hot face lining and a backup lining of material which may include an insulating material to reduce shell temperatures. Fig. 3.56 shows a typical lining in a steel ladle used in modern steelmaking to transport and treat molten steel and slag. Note the use of high alumina castable (85–95%  $\text{Al}_2\text{O}_3$ ) in the metal portion of the ladle with basic ( $\text{MgO}$ –chrome or  $\text{MgO}$ –carbon) brick in the area which must resist slag. The conditions to which refractories in ladles are subjected are very severe as the ladle will undergo several process cycles daily and may be used for complex

Fig. 3.56 Typical steel ladle lining.

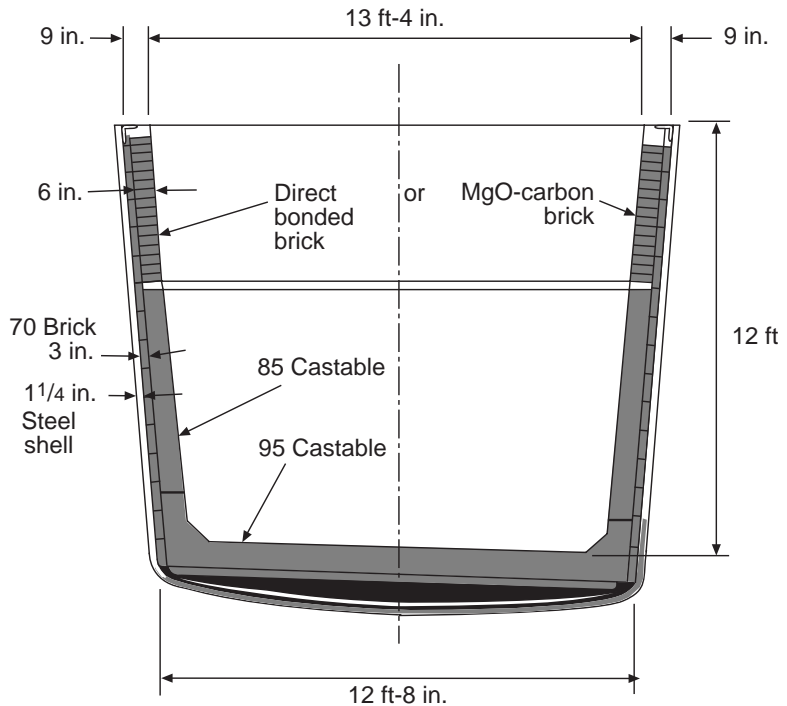
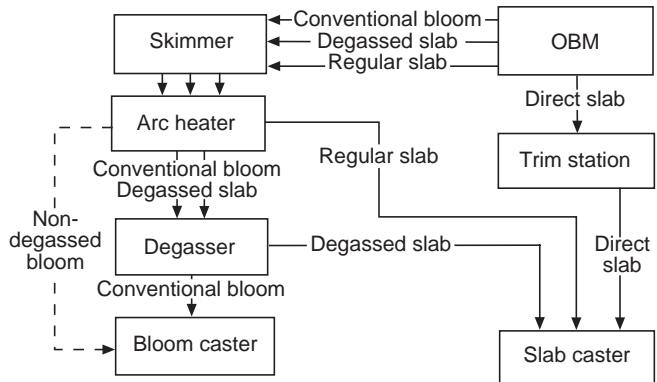


Fig. 3.57 Shop process routes.



ladle refining, arc reheating, degassing, or other treatments. Fig. 3.57 shows the different cycles to which ladles are exposed in one steelmaking shop which produces various slab and bloom heats.

Life of the working lining will range from as little as 20 heats for some slag lines to over 100 heats for the barrel or metal containing zone. Increased ladle wear will result from factors such as:

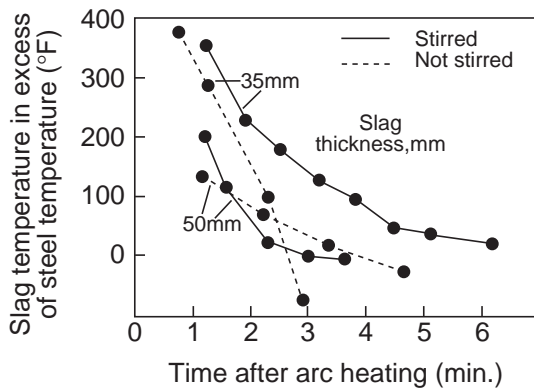
- higher tap temperatures,
- localized tap stream erosion,
- increased overall steel holding time,
- corrosion by superheated artificial slags during arc heating,
- thermomechanical cracking associated with ladle movements,
- more thermal cycling.

**Table 3.32 Properties of Various MgO–C Brick for Ladle Slag Lines**

Property	Better Resistance Obtained by
Arc Resistance	More graphite Higher purity graphite
Oxidation Resistance	Metal(s)
Hot Strength	Metal(s) Metals and higher purity graphite
Corrosion Resistance	High purity sintered grain High purity graphite Fused grain Combinations of above

Table 3.32 shows various changes which might be made in MgO–carbon brick to improve their life at the slag line. The exact brick selected will be based on the most economic materials in balance with the life of the remaining components of the ladle.

Slag line life will depend strongly on the extent of arc reheating and the manner in which it is conducted. Fig. 3.58 shows the extent to which slag is superheated depending on the thickness of the slag layer and the manner in which it is



**Fig. 3.58** Effect of slag thickness and stirring on slag superheat.

stirred with lances, porous plugs, or by electro-magnetic force. Increased superheat can increase refractory erosion 2–4 times the normal rates.

### 3.6.2 Metal Containment, Control and Protection

Fig. 3.59 shows a simple concept of the various refractories used in the modern casting process to contain, control and protect the steel between the steel ladle (top) and caster.

Various plates, rods, tubes, and linings are employed and their properties vary widely. All of these refractories must present the ultimate in

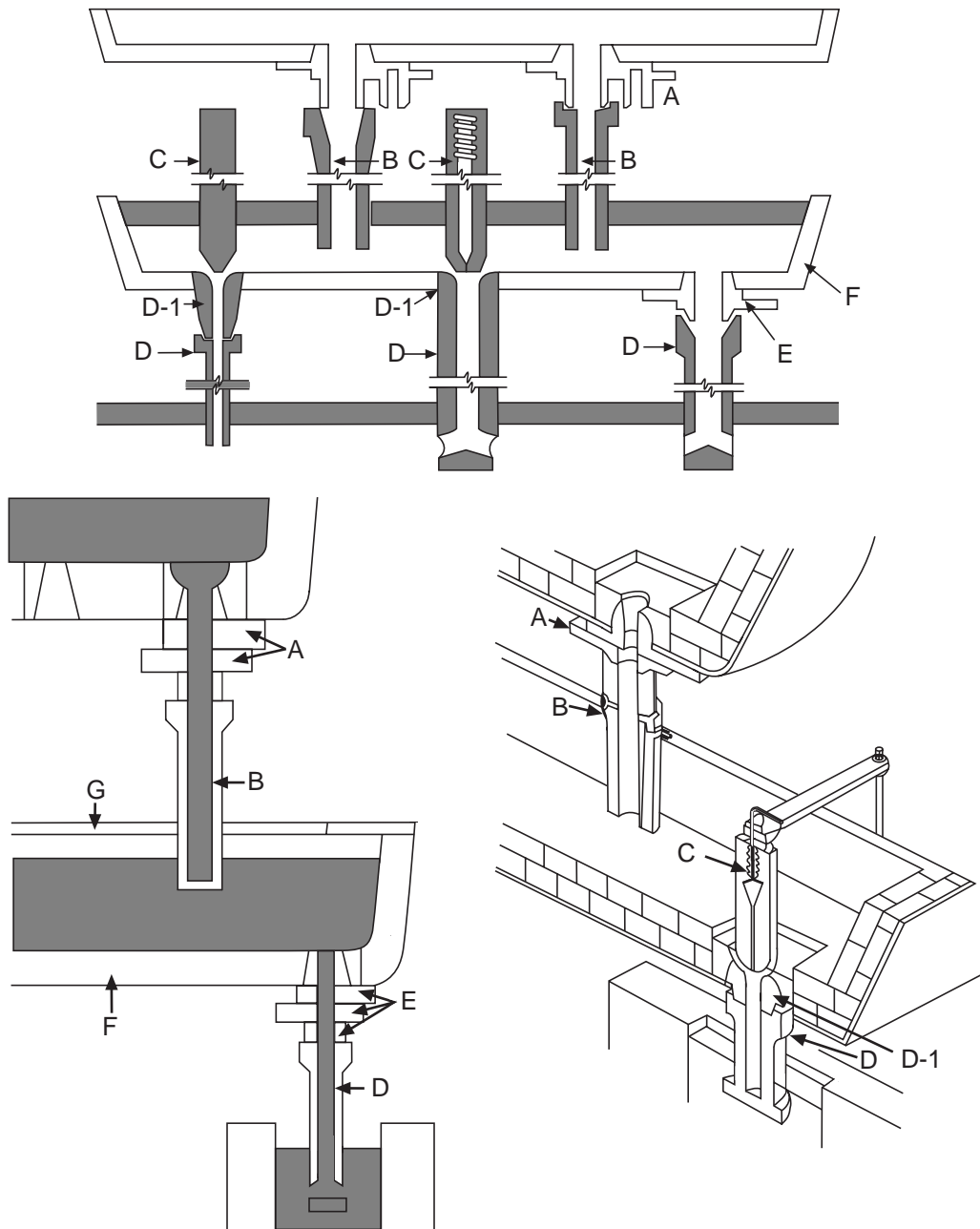
**Table 3.33 Typical Properties of Sliding Gate Plates—Conventional Type**

Type	High Alumina, > 92% Al <sub>2</sub> O <sub>3</sub>				
	85% Alumina	90% Alumina	Alumina/Chrome**	MgO	
Apparent porosity (%)	16	17	15	16	18
Bulk density (g/cm <sup>3</sup> )	2.88	3.00	3.15	2.95	2.91
Cold crushing strength (kg/cm <sup>2</sup> )	1700	1500	1500	1500	ND*
Thermal expansion (% at 1000°C)	0.65	0.67	0.78	0.57	ND*
MOR 2500°F (Pa × 10 <sup>5</sup> )	68	82	82	82	109
Major composition (%)					
Al <sub>2</sub> O <sub>3</sub>	87	90	95	87	
SiO <sub>2</sub>	11	8	3	9	
C***		2–3	2–3	2–3	2–3
Cr <sub>2</sub> O <sub>3</sub>				3	
MgO					95
Recommended applications	Mild, general	General	Throttling tundish	General, severe	Low C, billet

\*ND – No data available.

\*\*Replaces part of Al<sub>2</sub>O<sub>3</sub>.

\*\*\*Carbon from tar-impregnated which may be followed by partial coking.



**Fig. 3.59** Typical refractory components in the ladle to mold system. A = ladle slide gates, B = ladle to tundish shrouds, C = Tundish stopper rods, D = tundish to mold shrouds with associated nozzles (D-1), E = tundish slide gates, F = tundish linings, and G = tundish covers.

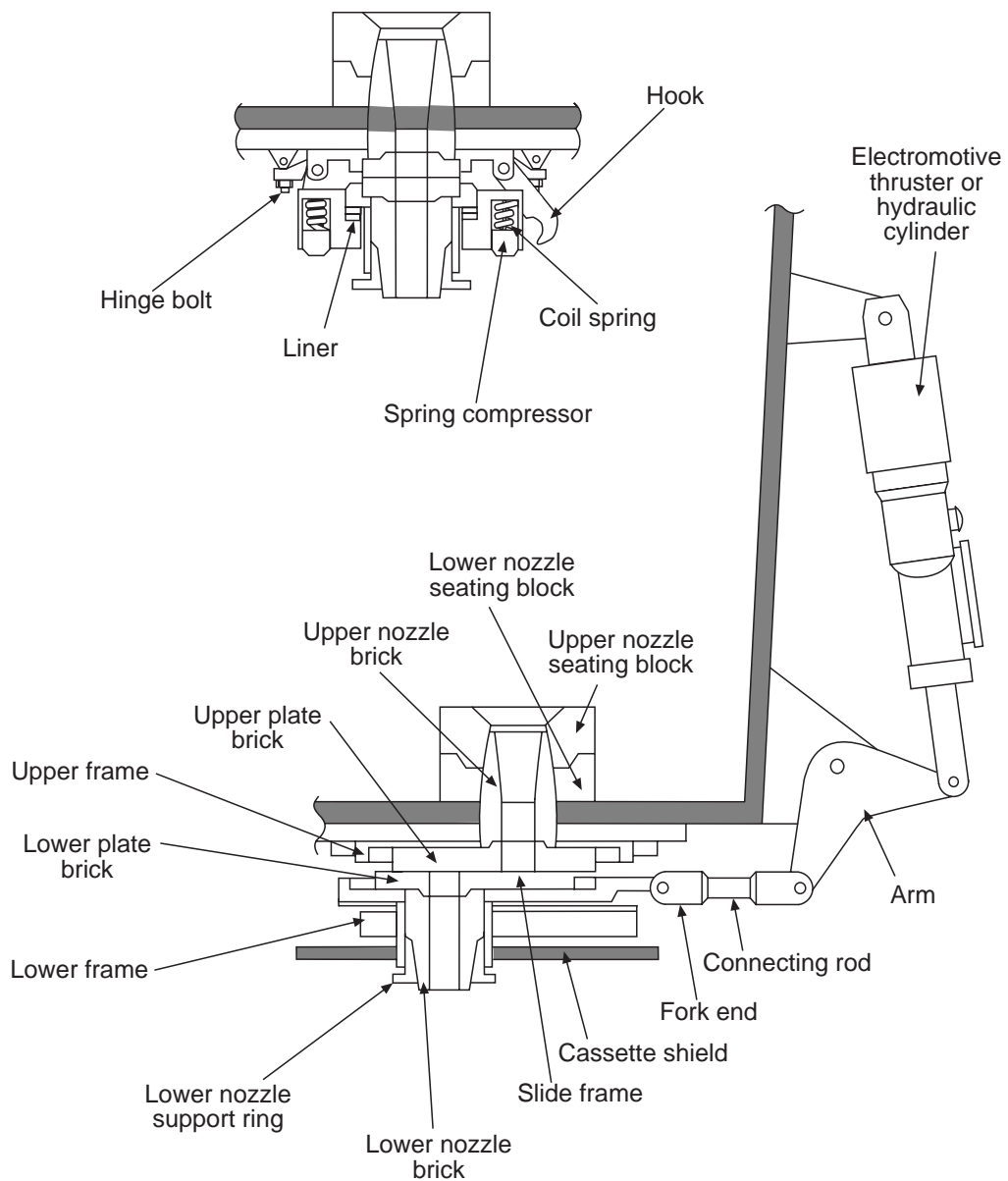
properties, such as thermal shock resistance, as they are exposed to instant temperature changes from ambient to steelmaking conditions. These refractories also must not erode or allow air infiltration to prevent deterioration to steel quality.

Tables 3.33 and 3.34 show properties of slide gate refractories.

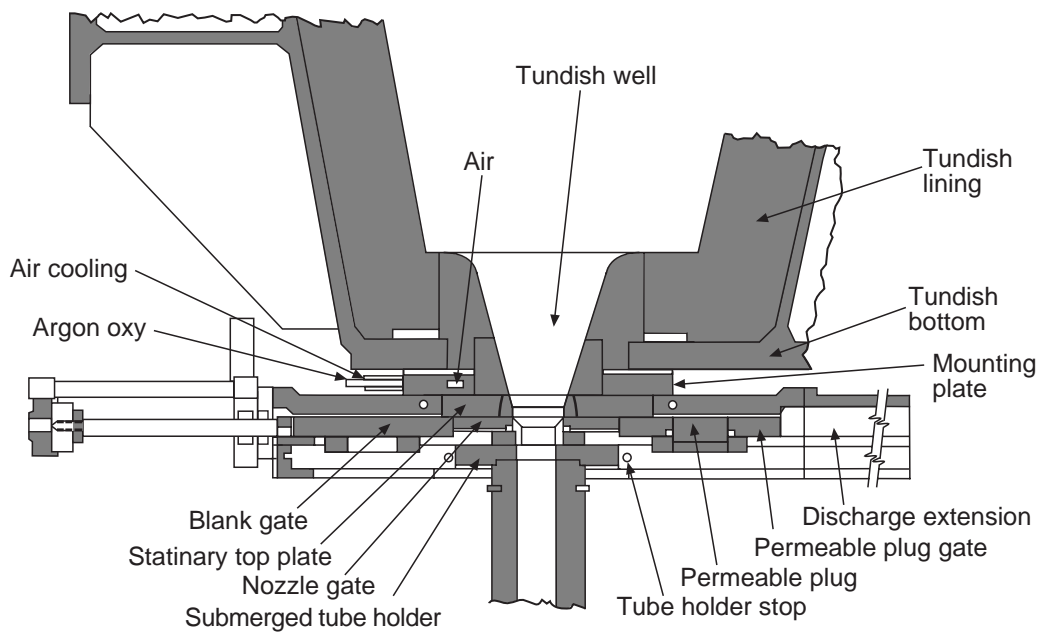
The materials are designed to function in either ladle and/or tundish gates as generally illustrated in Fig. 3.60 and Fig. 3.61.

**Table 3.34 Properties of Typical Higher Carbon Gate Plates**

Property	Alumina–Carbon-A	Alumina–Carbon-B	Alumina–Zirconia Carbon
Composition (%)			
Al <sub>2</sub> O <sub>3</sub>	89–92	68–75	70–75
SiO <sub>2</sub>	4–8	3–6	3–5
C	3–6	10–15	7–12
ZrO <sub>2</sub>			6–9
Density (g/cm <sup>3</sup> )	3.15–3.20	2.70–2.80	3.00–3.10
Porosity (%)	10–12	11–13	9–11



**Fig. 3.60** Typical ladle with system.



**Fig. 3.61** Tundish valve showing submerged pouring tube in position.

The sliding ladle gate uses air-cooled stainless steel springs to maintain a constant sealing pressure on the sliding refractory interfaces. A valve mechanism permits rapid opening or closing to replace or inspect refractory components. Refractories for ladle gates must have excellent resistance to thermal shock and metal erosion and maintain a smooth surface during use. Depending upon steel grade, plate life may be single or multiple heats without replacement or inspection. Consistency is vital because of the severe danger to personnel and equipment.

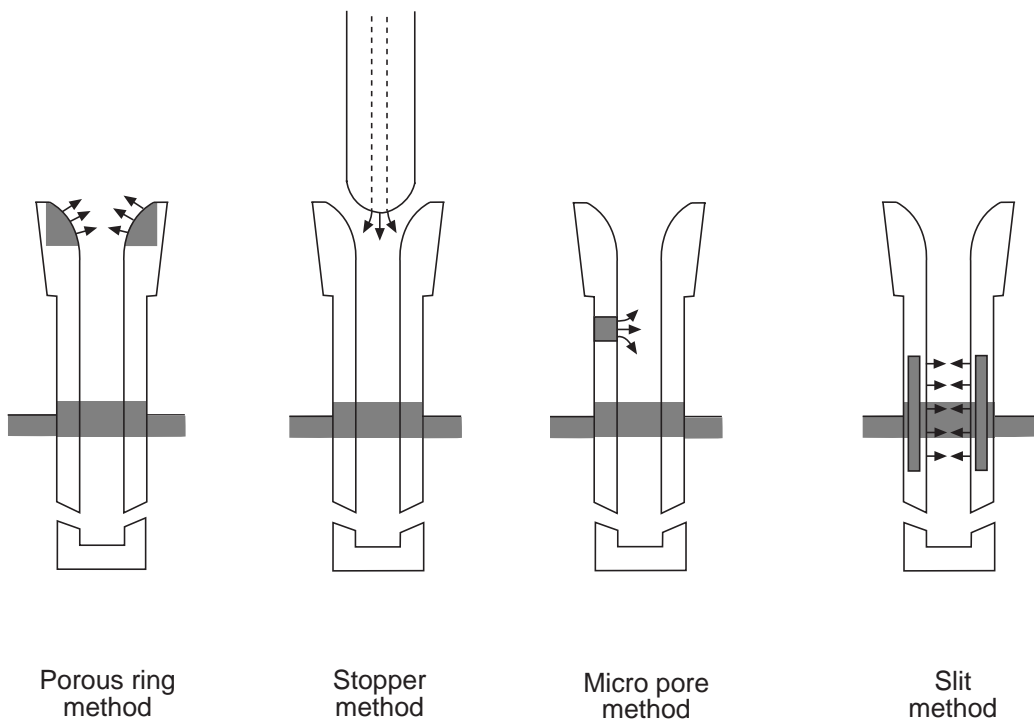
The tundish nozzle is a critical link in the continuous-casting system because it must deliver a constant and controlled rate of flow of steel to the mold with minimum stream flare to minimize spatter, spray and atmospheric oxidation. Because the ferrostatic head remains substantially constant in the tundish throughout casting of much of each heat, the bore of the nozzle must remain at a constant diameter throughout the cast.

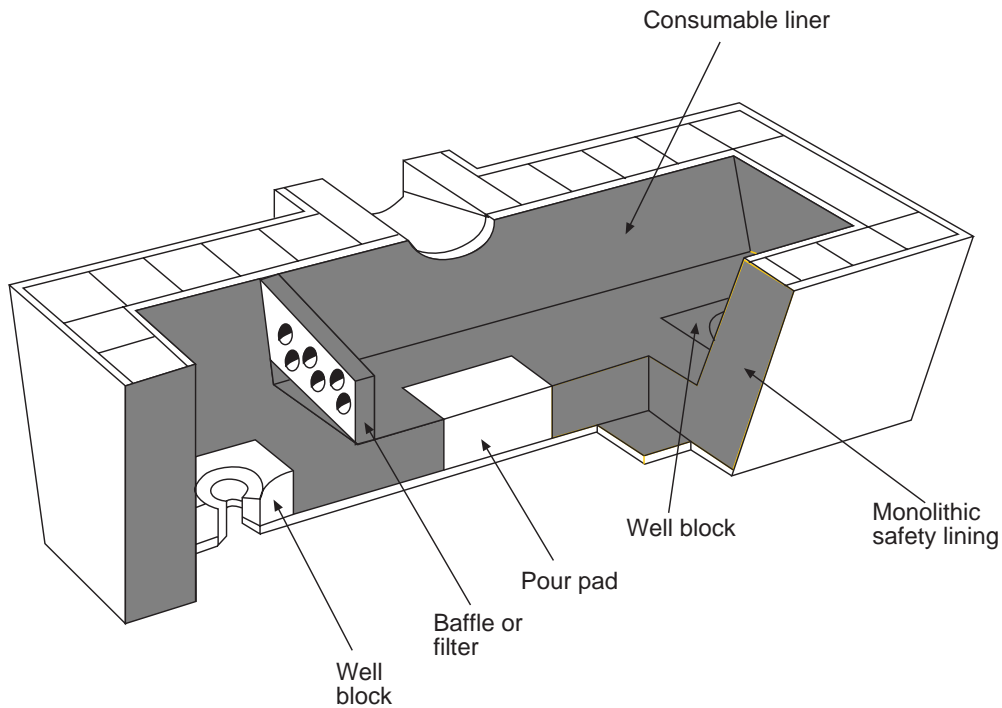
Tundish rods and ladle or tundish shrouds are made from isostatically pressed oxide-carbon combinations as illustrated in Table 3.35. These materials must have the ultimate resistance to thermal shock and erosion from steel and slag in the case of ladle to tundish shrouds or from steel and mold powders in the case of tundish to mold shrouds. Ladle to tundish shrouds may have lives of single or multiple heats whereas the tundish to mold shroud may be changed in mid-heat if clogging occurs from the buildup of deoxidation products such as  $\text{Al}_2\text{O}_3$ . Argon gas injection is usually supplied in one or more areas of the tundish to mold control system to minimize  $\text{Al}_2\text{O}_3$  formation and/or buildup as shown in Fig. 3.62. This requires that a specific portion of the refractory be produced with a sufficient permeability to direct the inert gas flow.

Refractory usage in the tundish proper continues to evolve as the tundish is required to remove and store undesirable materials in the tundish slag or on baffles or filters in the tundish. The refractory inner linings are thin consumable layers applied between strings of heats of like composition, as in Fig. 3.63. After each string of heats, the tundish and skull are dumped and a fresh refractory layer applied. The fresh layer, such as a gunnable  $\text{MgO}$  layer ~1–2 in. thick, provides a completely clean material to avoid any possible steel contamination. A monolythic safety lining and insulation provide for safety and low shell temperatures. The length of the string of heats is largely independent of the refractory as it depends on allowable slag buildup in the tundish and the need for a particular steel order.

**Table 3.35 Properties of Refractories for Shrouds and Tundish Rods**

Area Used	Composition (%)						Apparent Porosity (%)	Bulk Density (g/cm <sup>3</sup> )
	Al <sub>2</sub> O <sub>3</sub>	SiO <sub>2</sub>	C	ZrO <sub>2</sub>	MgO	Other		
<b>Base Al<sub>2</sub>O<sub>3</sub></b>								
Ladle-to-tundish shroud,	50–56	14–18	26–33			0–5	15–18	2.30–2.44
tundish-to-mold shroud, rod for tundish.	42–44	18–24	24–31	0–3		0–2	12–18	2.20–2.35
<b>Fused silica</b>								
ladle-to-tundish shroud, tundish-to-mold shroud.	≤ 0.3	≥ 99					12–17	1.82–1.90
<b>ZrO<sub>2</sub>-C</b>								
Slag line or nozzle of tundish-to-mold shroud, head of rod.	1–2	5–7	7–10 20–25	75–80 67–74		0–2 0–2	12–16 15–18	3.57–4.18 3.20–3.60
<b>MgO-C</b>								
Nozzle of tundish to mold shroud, head of rod		0–2 12–16	5–9 10–20		85–92 58–78		15–18 14–17	2.46–2.51 2.25–2.50

**Fig. 3.62** Inert gas bubbling methods used to decrease alumina clogging problems.

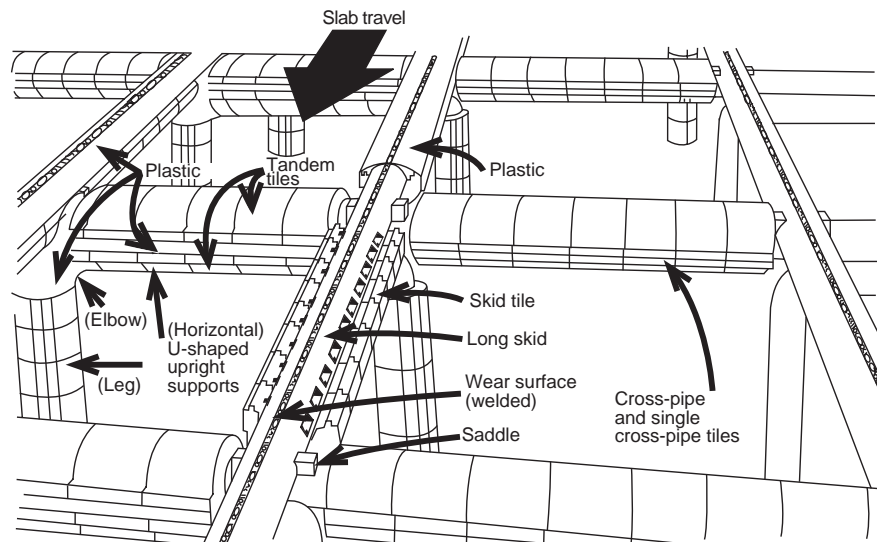


**Fig. 3.63** Consumable liner in tundish for clean steel practice and to facilitate skull removal.

### 3.6.3 Refractory Use for Energy Savings

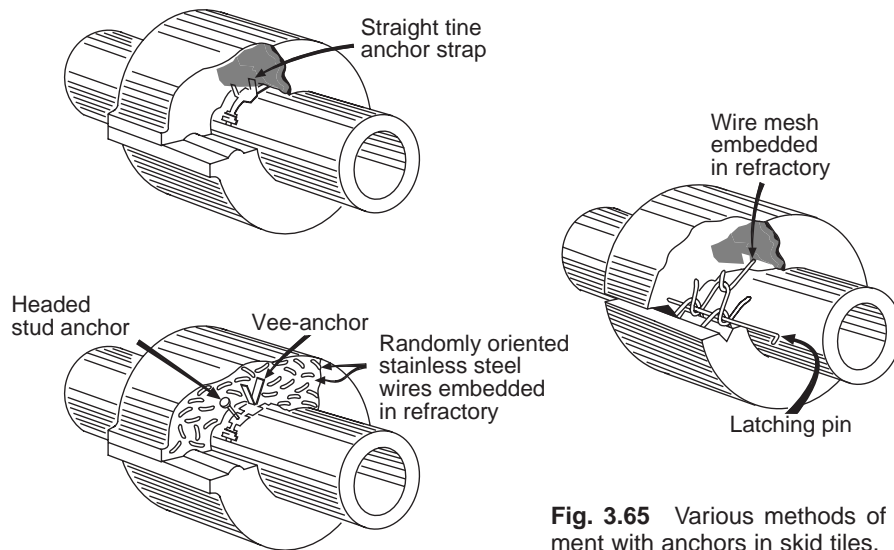
Although refractories always provide a degree of thermal insulation, there are some steel plant applications where these criteria are more important than containment or steel quality protection.

In slab reheating furnaces, refractories are used over the areas of the skid pipe system not in contact with the slab to decrease energy usage, as illustrated in Fig. 3.64. Special refractory metal anchoring systems or interlocking refractory shapes are used in this application to resist vibration and facilitate skid insulation replacement. Fig. 3.65 shows some examples of methods of holding refractory tile on to a skid pipe system.



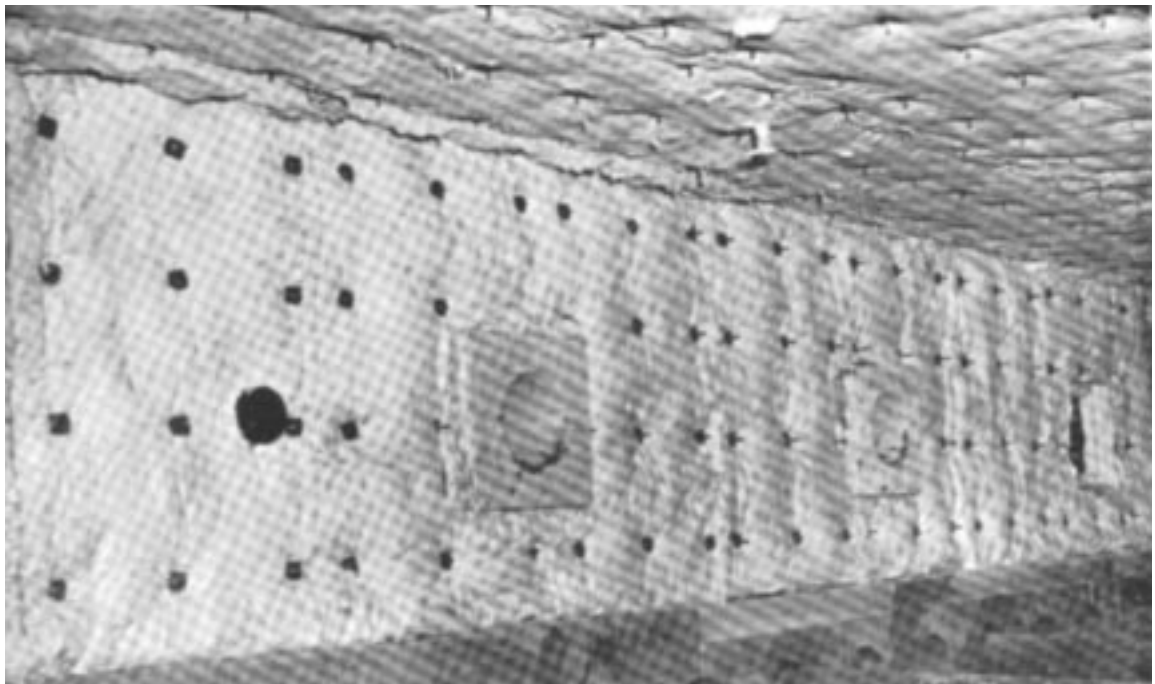
**Fig. 3.64** Identification of the major components of a skid pipe system.





**Fig. 3.65** Various methods of using metallic enhancement with anchors in skid tiles.

In recent years, increased use has been made of various forms of fiber refractory materials in many types of reheating furnaces because of their good insulating properties and light weight. Such materials are not suitable in contact with slag or in areas requiring abrasion resistance, but are suitable for many less severe areas. Fig. 3.66 shows a plate mill continuous-annealing furnace lined with fiber blanket held in place with metallic anchors. Refractory type anchors may be used in such a system to extend the useful temperature of fibers. Fibers may also be used in stackbonded or modular form where the fibers are folded or fastened to a steel backup plate attached directly to the steel super-structure. Veneers of fiber are also being evaluated over existing refractory linings to reduce energy consumption. In all cases, the economies of fiber materials must be carefully evaluated in comparison to other insulating materials including insulating brick, insulating castables and mineral wool or other insulating blocks.



**Fig. 3.66** Plate mill continuous annealing furnace with fiber blanket wallpaper construction.

Fibers offer added advantages when operating equipment under cyclic conditions because of their low heat storage characteristics.

### 3.7 Refractory Consumption, Trends, and Costs

Some general comments on refractory consumption, costs and trends are made here for illustrative purposes. Because this type of information changes rapidly with changes in the steelmaking process, changes in refractory technology, changes in economic conditions, and changes in environmental factors, care must be taken to gather updated information for any specific use. Also, comparing such data between countries (or even companies) must be done only after an understanding in the wide differences in conditions. Consideration must be given regarding integrated and nonintegrated shops and between the types of steel products being produced.

The types of refractories used in recent years trend toward more use of monolithic and special shaped products with less standard brick being used. This trend reflects the drive for both lower labor costs and the changes in the process to produce higher quality steel products. Tables 3.36 and 3.37 show the distribution of refractory product types for an integrated and nonintegrated plant in

**Table 3.36 Breakdown of U.S. Refractory Usage—Integrated Plant**

Refractory Type	Percentage In Indicated Form		
	Brick	Shapes	Monolithic
All	49	15	36
Silica	5	25 †	
Fireclay	15		25
High alumina	19	58	30
Al <sub>2</sub> O <sub>3</sub> -SiC-C	10		20
Burned basic	22		
Magnesia carbon	25*	2	
Other MgO		5 ‡	23§
Miscellaneous	3	10	2
Total	100	100	100

\* All types including tempered, impregnated, graphite bearing. ‡ Mainly tundish boards.

† Mainly fused-silica shrouds and coke oven shapes.

§ Mainly basic gun materials.

**Table 3.37 Breakdown of U.S. Refractory Usage—Nonintegrated Plant**

Refractory Type	Percentage In Indicated Form		
	Brick	Shapes	Monolithic
All	41	15	44
Silica		25 †	
Fireclay	11		12
High alumina	30	55	21
Al <sub>2</sub> O <sub>3</sub> -SiC-C		5	
Burned basic	15		
Magnesia carbon	40*	2	
Other MgO		5‡	65§
Miscellaneous	4	8	2
Total	100	100	100

\* Mainly graphite bearing.

† Mainly fused-silica shrouds

‡ Mainly tundish boards.

§ Mainly basic gun materials.

**Table 3.38 Major Areas of High-Alumina Refractory Usage in the Steel Plant**

Type of High Alumina Product Used		Desirable Refractory Features	Future U.S. Directions
Process Area	Application		
<b>Blast furnace</b>	1. Furnace lining	90% Al <sub>2</sub> O <sub>3</sub> , Al <sub>2</sub> O <sub>3</sub> -Cr <sub>2</sub> O <sub>3</sub> brick, 60-70% Al <sub>2</sub> O <sub>3</sub> brick, often tar-impregnated	More nonoxide SiC, graphite-type brick
	2. Stove—hot/air system	Creep-resistant brick (60-80)	Longer life/high quality Al <sub>2</sub> O <sub>3</sub> types
	3. Cast house (troughs, runners, spouts)	Al <sub>2</sub> O <sub>3</sub> -SiC-C or high-alumina castables, plastics, ram mixes	Increased Al <sub>2</sub> O <sub>3</sub> -SiC-C types as metal treatment increases
	4. Hot-metal transfer/treatment (torpedo ladles, mixers, lances, stirrers)	Burned and impregnated high-Al <sub>2</sub> O <sub>3</sub> products (70-80) Al <sub>2</sub> O <sub>3</sub> -SiC-C brick for metal treatment(s)	Cycle resistance
<b>Steelmaking</b>	1. Runners EAF	Al <sub>2</sub> O <sub>3</sub> -SiC-C monolithics	Increased use replacing older material types
	2. Delta sections, smoke rings-EAF	Low-moisture high-alumina castables	
<b>Ladles</b>	1. Linings	Brick (70-80) Low-moisture castables (70-95)	Increased castable use. Higher alumina with clean-steel practices.
	2. Pads-blocks	Low-moisture castables preformed	Increased use with clean-steel practices. Increased use over brick or other materials
	3. Lances	Low-moisture castables preformed	
	4. Permeable plugs	Fired shapes	
<b>Tundish</b>	1. Safety Linings	Low-moisture castable	Increased use over brick or other materials
	2. Covers	Low-moisture castable	
<b>Shrouds</b>	1. Ladle-to-tundish	Al <sub>2</sub> O <sub>3</sub> -C	Increased use with decreased fused-silica use
	2. Tundish-to-mold	Al <sub>2</sub> O <sub>3</sub> -C	
<b>Slide gates</b>	Ladle and tundish	Fired impregnated Al <sub>2</sub> O <sub>3</sub> Al <sub>2</sub> O <sub>3</sub> -Cr <sub>2</sub> O <sub>3</sub> Al <sub>2</sub> O <sub>3</sub> -C	Increased use of alumina-carbon types. Repair of plates
<b>Reheating furnaces</b>	Linings	High-alumina plastics, castables, preformed shapes, fibers	Continued emphasis on energy savings and ease of installation

**Table 3.39 Projected USA Refractory Usage in Indicated Plant**

Area	Consumption (kg/ton)	
	Integrated Plant	Nonintegrated Plant
Coke oven	0.40	
Blast furnace	0.45	
Cast house	2.55	
Hot-metal transfer and treatment	2.25	
Steelmaking	3.05	4.00
Steel ladles & ladle metallurgy	3.60	4.05
Gates or rods/tubes	0.65	1.05
Tundish	1.25	1.65
Finishing	1.25	1.25
Total	15.45	12.00

the United States. Each of these product types show complex trends in refractory use and some of these will be obvious by reading other chapters which highlight refractory uses in specific cases. Table 3.38, for example, shows some of the trends in the use of high  $Al_2O_3$  products in the steelplant. Iron or steel processing changes have driven such trends as increased use of high  $Al_2O_3$  materials in blast furnace casthouses which now cast on an almost continuous basis, steel ladle refractories exposed to more severe conditions during ladle treatment of steels, or the increased use of stream shrouding devices during casting to prevent oxidation.

The consumption of refractories (in terms of lbs of refractories per ton of steel produced) continues to decrease both from improved life and because modern processes are ever more productive. At the same time, the cost of refractories per ton is increased as refractories are improved to meet the new process conditions. Table 3.39 shows the current refractory consumption in two United States steelplants. As previously stated, these figures vary widely and comparisons between shops should not be attempted without a full knowledge of process conditions and parameters. The cost of refractories produced will also vary widely from \$0.20 to over \$2.50 per lb depending on composition and complexity. The cost of refractories per ton of steel produced for an integrated plant of the type shown in Table 3.39 would range from \$9.00 to \$12.00 per ton of steel produced.

It should also be noted that refractory costs are often secondary to other parameters including steel quality, performance predictability and safety, energy considerations, and environmental criteria.

## References

1. W.T. Lankford *et al.*, *The Making, Shaping and Treating of Steel*, 10th ed. (Pittsburgh: Association of Iron and Steel Engineers, 1985), 37-96.
2. M.A. Rigaud and R.A. Landy, eds., *Pneumatic Steelmaking, Volume Three, Refractories* (Warrendale, PA: Iron and Steel Society, 1996).
3. *Modern Refractory Practice*, 5th ed., (Pittsburgh: Harbison-Walker Refractories, 1992).
4. C.A. Schacht, "Improved Mechanical Material Property Definition for Predicting the Thermo-mechanical Behavior of Refractory Linings of Teeming Ladles", *J. Am. Ceram. Soc.*, 76 (1), 202-206.
5. J.A. Boggs, et al, "Thermal Mechanical Effects on the Structural Integrity and Service Life of Ladle Refractory, in Secondary Metallurgical Process", *Iron and Steelmaker*, June 1992, 33.